

AD 2. AERODROMES**SUMU AD 2.9-1 AERODROME LOCATION INDICATOR AND NAME**

SUMU - MONTEVIDEO/Intl of Carrasco "Gral. Cesáreo L. Berisso"

SUMU 2.9-2 AERODROME GEOGRAPHICAL AND ADMINISTRATIVE DATA

1	<i>ARP coordinates and site at AD</i>	345002S 0560141W Location: 309 M SW of "CRR"VOR/DME
2	<i>Direction and distance from (city)</i>	18 KM E from Montevideo city
3	<i>Elevation/Reference temperature</i>	32 M (105 FT) / 29°C
4	<i>Geoid undulation at AD ELEV PSN</i>	14 M
5	<i>MAG VAR/Annual change</i>	☛ 11° W (JAN 2020) / 0.14° increasing
6	<i>AD operator, address, telephone, telefax, e-mail address, AFS address, website address</i>	Puerta del Sur S.A. Aeropuerto Intl de Carrasco "Gral. Cesáreo L. Berisso" Canelones Tel: (598) 2604 0329 Telefax OPS: (598) 2604 0332 – (598) (0)99 673 888 e-mail: Operaciones@aerpuertodecarrasco.com.uy AFS: SUMUYDYX Website address: www.aerpuertodecarrasco.com.uy
7	<i>Types of traffic permitted (IFR/VFR)</i>	IFR/VFR
8	<i>Remarks</i>	Administrative Coordinator: DINACIA Ramp services: CANDYSUR SA Tel.: (598) 2604 0000; Fax: (598) 2604 0374 – (OPS): (598) 2604 0377 e-mail: candysur@candysur.com.uy

SUMU AD 2.9-3 OPERATIONAL HOURS

1	<i>AD Operator</i>	11:00 to 20:00 UTC
2	<i>Customs and immigration</i>	H24
3	<i>Health and sanitation</i>	Medical Service at the Aerodrome H24 – UCM Tel: 2604 03 29 Ext 1000 (Puerta del Sur Security Control Centre)
4	<i>AIS Briefing Office</i>	H24
5	<i>ATS Reporting Office (ARO)</i>	H24
6	<i>MET Briefing Office</i>	H24
7	<i>ATS</i>	H24

8	<i>Fuelling</i>	<ul style="list-style-type: none"> ☛ ANCAP: H24. Tel.: (598) 2604 4473; (598) 2604 0329 extension 1279; (598) 2604 4486 ☛ AXION ENERGY: H24. Tel.: (598) 2604 0283; (+598) (0)91 382 382, (+598) (0)91 384 384. Orders are held from 09:00 to 01:00 ☛ UTC. ☛ PETROBRAS: H24. Tel.: (598) 2200 9920 extension 5140 and 5141
9	<i>Handling</i>	H24
10	<i>Security</i>	H24
11	<i>De-icing</i>	Nil
12	<i>Remarks</i>	Nil

SUMU AD 2.9-4 HANDLING SERVICES AND FACILITIES

1	<i>Cargo-handling facilities</i>	<ul style="list-style-type: none"> ☛ 4 pallet loaders / containers of 7000 KG; 2 pallet loaders / containers of 16000 KG; 8 conveyor belts; 110 WB dollies; 1 dollie of 20 FT; 29 roof luggage carts; 22 simple luggage carts; 16 towing tractors.
2	<i>Fuel/oil types</i>	<ul style="list-style-type: none"> ☛ AVGAS 100; JET A-1 ☛ Oil (PETROBRAS): Aeroshell: W100, W120, 100, Grease 5, Grease 6, Grease 7, Grease 14, Grease 22, Oil 15W/50, Fluid 41, Turbine Oil 500, Turbine Oil 750
3	<i>Fuelling facilities/capacity</i>	<ul style="list-style-type: none"> ☛ ANCAP: AVGAS 100: 1 movable unit of 900 L; JET A-1: 3 movable units of 30 000 L each; 7 tanks of 70 000 L each. ☛ AXION: JET A-1: 3 tanks of 90 000 L each and 60 000 L in movable units. ☛ PETROBRAS: AVGAS 100: 1 tank of 19 500 L and 1 movable unit of 3 500 L. JET A-1: 4 tanks of 90 000 L and 85 000 L in movable units.
4	<i>De-icing facilities</i>	Nil
5	<i>Hangar space for visiting aircraft</i>	<ul style="list-style-type: none"> ☛ For availability contact with: (+598) (0)99 673 870 ☛ e-mail: fbo@aeropuertovipclub.com.uy
6	<i>Repair facilities for visiting aircraft</i>	Nil
7	<i>Remarks</i>	<ul style="list-style-type: none"> ☛ 2 generating sets of 120 KVA; 7 generating sets of 90 KVA; 2 power supplies of 120 KVA; 4 turbine starters; 5 aircraft towing tractors and 21 aircraft towing bars.

SUMU AD 2.9-5 PASSENGER FACILITIES

1	<i>Hotels</i>	In the city
2	<i>Restaurants</i>	H24
3	<i>Transportation</i>	Bus service, taxis and car rental from the AD

4	<i>Medical facilities</i>	Medical Service at the Aerodrome H24 – UCM Tel: 2604 03 29 Ext 1000 (Puerta del Sur Security Control Centre)
5	<i>Bank and Post Office</i>	Exchange: H24. Post Office: Nil
6	<i>Tourist Office</i>	11:00 to 01:00 UTC
7	<i>Remarks</i>	Nil

SUMU AD 2.9-6 RESCUE AND FIRE FIGHTING SERVICES

1	<i>AD category for fire fighting</i>	CAT 09 3 CFRR OSHKOSH T 3000 vehicles with: 11 356 L of water, 1 590 L of A FFF foam and 250 KG chemical powder each 1 CFRR OSHKOSH TI 3000 vehicle with: 11 356 L of water, 1 514.16 L of A FFF foam and 250 KG chemical powder 1 command vehicle Nissan Frontier twin cabin FWD. 1 Mahindra single cabin FWD vehicle with intervention equipment fast pressure of 100 bar and capacity of 300 Lts of water, 50 Lts of AFFF foam and 50Kg of chemical powder equipment.
2	<i>Rescue equipment</i>	Tools and approach equipment
3	<i>Capability for removal of disabled aircraft</i>	In coordination with the Aerodrome Operator Puerta del Sur S.A.
4	<i>Remarks</i>	From SUMU with FAU aircrafts including FAU rescue personnel and firefighters.

SUMU AD 2.9-7 SEASONAL AVAILABILITY - CLEARING

1	<i>Types of clearing equipment</i>	Mechanical sweeper
---	------------------------------------	--------------------

SUMU AD 2.9-8 APRONS, TAXIWAYS AND CHECK LOCATIONS/POSITIONS DATA

1	<i>Apron surface and strength</i>	Surface: SE apron: concrete and asphaltic concrete. Commercial Apron I: concrete. Commercial Apron II: Concrete. Strength: Commercial Apron II: 82/R/C/X/U and 88/F/C/W/U; SE: 23/F/C/X/T, Commercial Apron I: 82/R/C/X/U
2	<i>Taxiway width, surface and strength</i>	Width: 23 M Surface: asphaltic concrete Strength: TWY A: 88/F/C/W/U. ☛ TWY B BTN TWY D and RWY 25: 82/R/C/X/U and 88/F/C/W/U. TWY F: 23/F/C/X/T. ☛ TWY C BTN RWY 07-25 and Apron: 88/F/C/W/U. ☛ TWY C BTN RWY 07-25 and RWY 01-19: 40/F/C/X/T. TWY D: 82/R/C/X/U. TWY E: 88/F/C/W/U. TWY G: 82/R/C/X/U

3	<i>Altimeter checkpoint location and elevation</i>	E apron 15 M; W apron 15 M.
4	<i>VOR checkpoints</i>	TWY C 344930.67S/0560145.78W (See Ad/Heliport Chart)
5	<i>VOR/INS checkpoints</i>	NIL
6	<i>Remarks</i>	TWY to general aviation PRKG only AVBL for ACFT up to 12500 LB. ● Taxiway (TWY) C between RWY 07-25 and RWY 01-19 and TWY F, limited to aircraft with code letter "C" up to 36M span / Ex: Boeing 737, Airbus 321.

SUMU AD 2.9-9 SURFACE MOVEMENT GUIDANCE AND CONTROL SYSTEM AND MARKINGS

1	<i>Use of aircraft stand ID signs, TWY guide lines and visual docking/parking guidance system of aircraft stands</i>	Aircraft stands identification signs. TWY centre line signs and nose aircraft stop bar, with aircraft type ID. Visual docking guidance system: Nil
2	<i>RWY and TWY markings and LGT</i>	<p>● RWY 07: <u>Markings</u>: pre-THR zone, PERM displaced THR, transverse stripe, THR, RWY designation, RWY centre line, lateral stripe, touchdown zone, aiming point, and 180° turn-over for ACFT up to code letter E. <u>LGT</u>: RWY THR identification, THR, RWY edge, RWY centre line, RWY end and stopway lights.</p> <p>● RWY 25: <u>Markings</u>: pre-THR zone, PERM displaced THR, transverse stripe, THR, RWY designation, RWY centre line, lateral stripe, touchdown zone, aiming point. <u>LGT</u>: THR, RWY edge, RWY centre line, and RWY end lights.</p> <p>RWY 19: <u>Markings</u>: pre-THR zone, THR, RWY designation, RWY centre line, lateral stripe, touchdown zone, aiming point, and 180° turn-over for ACFT up to code letter E. <u>LGT</u>: THR, RWY edge, and RWY end lights.</p> <p>RWY 01: <u>Markings</u>: pre-THR zone, THR, RWY designation, RWY centre line, lateral stripe, aiming point, and 180° turn-over for ACFT up to code letter E. <u>LGT</u>: RWY THR identification, THR, RWY edge, and RWY end lights.</p> <p>TWY: <u>Markings</u>: TWY centre line, lateral, enhanced TWY centre line, mandatory instructions, RWY holding position, intermediate holding position, paved margins, directional signal to the parking stands before entering platform. <u>LGT</u>: TWY edge lights.</p>
3	<i>Stop bars</i>	Nil
4	<i>Remarks</i>	Nil

SUMU AD 2.9-10 AERODROME OBSTACLES

<i>In Area 2</i>					
<i>OBST ID/ Designation</i>	<i>OBST type</i>	<i>OBST position</i>	<i>ELEV/HGT</i>	<i>Markings/ Type, colour</i>	<i>Remarks</i>
a	b	c	d	e	f
No data					

<i>In Area 3</i>					
<i>OBST ID/ Designation</i>	<i>OBST type</i>	<i>OBST position</i>	<i>ELEV/HGT</i>	<i>Markings/ Type, colour</i>	<i>Remarks</i>
a	b	c	d	e	f
No data					

SUMU AD 2.9-11 METEOROLOGICAL INFORMATION PROVIDED

1	<i>Associated MET Office</i>	CARRASCO
2	<i>Hours of service MET Office outside hours</i>	H 24
3	<i>Office responsible for TAF preparation Periods of validity</i>	Surveillance MET Office CARRASCO H 24
4	<i>Trend forecast Interval of issuance</i>	TREND 2 H
5	<i>Briefing/consultation provided</i>	P, T
6	<i>Flight documentation Language(s) used</i>	C, PL Spanish
7	<i>Charts and other information available for briefing or consultation</i>	S, U, P, T, W SWH, SWM, SWL
8	<i>Supplementary equipment available for providing information</i>	✉ jefatura.dma@inuket.gub.uy ✉ direccion.dsm@inuket.gub.uy
9	<i>ATS units provided with information</i>	CARRASCO TWR, APP, ACC, OPS, AIC, COM
10	<i>Additional information (limitation of service, etc.)</i>	✉ Tel: +598 26040299 (OVM-OMA-SUMU) ✉ Tel: +598 26040329 extension 1235, 1234 (OVM-OMA-SUMU), Predictor cell phone: +598 91081082 ✉ Head Tel: +598 26040154 ✉ Head cell phone: +598 99316497 ✉ Direction Tel: +598 1895 extension 203 ✉ Direction cell phone: +598 91253053

SUMU AD 2.9-12 RUNWAY PHYSICAL CHARACTERISTICS

<i>Designations RWY NR</i>	<i>TRUE BRG</i>	<i>Dimensions of RWY (M)</i>	<i>Strength (PCN) and surface of RWY and SWY</i>	<i>THR coordinates. RWY end coordinates. THR geoid undulation</i>	<i>THR elevation and highest elevation of TDZ of precision APP RWY</i>
1	2	3	4	5	6
07	053.54°	3 200 x 45	88/F/C/W/U Concrete and asphaltic concrete	345031.64S 0560212.96W 345038.38S 0560224.04W GUND 14.0 M	THR 18 M/59 FT TDZ 22 M/72 FT
25	233.53°	3 200 x 45	88/F/C/W/U Hormigón y concreto asfáltico	344939.56S 0560047.49W 344936.68S 0560042.75W GUND 14.0 M	THR 31 M/102 FT TDZ 31 M/102 FT
01	359.41°	2 250 x 45	55/F/C/W/T Concreto asfáltico	345031.09S 0560150.65W 345031.09S 0560150.65W GUND 14.0 M	THR 19 M/62 FT TDZ 21 M/69 FT
19	179.41°	2 250 x 45	55/F/C/W/T Concreto asfáltico	344918.08S 0560151.56W 344918.08S 0560151.56W GUND 14.0 M	THR 15 M/51 FT TDZ 19 M/62 FT

Slope of RWY-SWY	SWY dimensions (M)	CWY dimensions (M)	Strip dimensions (M)	OFZ	RESA (M)	Remarks
7	8	9	10	11	12	13
+0.77%/+0.45%/+0.52%/+0.49%/+0.47%/+0.54%/-0.27%/ +0.99%/+0.93%/+1%/+0.8% (350 M) (240 M) (240 M) (390 M) (180 M) (270 M) (540M) (420 M) (165 M) (255 M) (150 M)	150 x 45	150 x 45	3 320 x 300	Nil	90 x 90	See Runway strip – Aerodrome Chart
-0.8%/-1%/-0.93%/-0.99%/ +0.27%/-0.54%/-0.47%/-0.49%/-0.52%/-0.45%/-0.77% (150 M) (255 M) (165 M) (420 M) (540 M) (270 M) (180 M) (390 M) (240 M) (240 M) (350 M)	Nil	Nil	3 320 x 300	Nil	90 x 70	See Runway strip – Aerodrome Chart
+0.8%/+0.5%/+0.3%/-0.4%/-0.1%/ +0.2% (150 M) (165 M) (330 M) (605 M) (525 M) (475 M)	Nil	Nil	2 370 x 150	Nil	90 x 90	See Runway strip – Aerodrome Chart
+0.2%/+0.1%/+0.4%/-0.3%/-0.5%/-0.8% (475 M) (525 M) (605 M) (330 M) (165 M) (150 M)	Nil	Nil	2 370 x 150	Nil	75 x 90	See Runway strip – Aerodrome Chart

SUMU AD 2.9-13 DECLARED DISTANCES

RWY Designator	TORA (M)	TODA (M)	ASDA (M)	LDA (M)	Remarks
1	2	3	4	5	6
07	3 050	3 200	3 200	2 700	Nil
25	3 200	3 200	3 200	3 050	Nil
01	2 250	2 250	2 250	2 250	Nil
19	2 250	2 250	2 250	2 250	Nil

SUMU AD 2.9-14 APPROACH AND RUNWAY LIGHTING

<i>RWY Desig- nator</i>	<i>APCH LGT type LEN INTST</i>	<i>THR LGT colour WBAR</i>	<i>VASIS (MEHT) PAPI</i>	<i>TDZ, LGT LEN</i>	<i>RWY Centre Line LGT Length, spacing, colour, INTST</i>	<i>RWY edge LGT LEN, spacing colour INTST</i>	<i>RWY End LGT colour WBAR</i>	<i>SWY LGT LEN (M) colour</i>	<i>Remarks</i>
1	2	3	4	5	6	7	8	9	10
07	SALS 420 M LIM	Green	PAPI	Nil	3050 M, 30 M, White	3050 M, 60 M White Amber	- Red	150 M Red	Nil
25	MALSR CAT I 900 M LIM	Green	PAPI	Nil	3200 M, 30 M, White	3200 M, 60 M White Amber	- Red	Nil	Nil
01	SALS 420 M LIM	Green	PAPI	Nil	Nil	2250 M, 60 M White Amber	- Red	Nil	Nil
19	MALSR CAT I 720 M LIM	Green	PAPI	Nil	Nil	2250 M, 60 M White Amber	- Red	Nil	Nil

SUMU AD 2.9-15 OTHER LIGHTING, SECONDARY POWER SUPPLY

1	<i>ABN/IBN location, characteristics and hours of operation</i>	ABN: Old Terminal building/ IBN: Nil
2	<i>LDI location and LGT Anemometer location and LGT</i>	LDI: Nil Anemometer: in THR 07, THR 25 and in THR 19
3	<i>TWY edge and centre line lighting</i>	Edge: blue lights Centre: Nil
4	<i>Secondary power supply/switch-over time</i>	Secondary power supply for the entire airport. Switch-over time: 10 SEC
5	<i>Remarks</i>	Anemometer secondary power supply (runway 25 only), immediate switch-over time

SUMU AD 2.9-16 HELICOPTER LANDING AREA

1	<i>Coordinates TLOF or THR of FATO Geoid undulation</i>	Nil
2	<i>TLOF and/or FATO elevation M/FT</i>	Nil
3	<i>TLOF and FATO area dimensions, surface, strength, marking</i>	Nil
4	<i>True BRG FATO</i>	Nil
5	<i>Declared distance available</i>	Nil
6	<i>APP and FATO lighting</i>	Nil
7	<i>Remarks</i>	Remote point H. Coord: 345015.18S 0560124.14W

SUMU AD 2.9-17 ATS AIRSPACE

1	<i>Designation and lateral limits</i>	<p>CARRASCO TMA Straight line which join the following points (UGIMI) 345858S/0565302W up to 343300S/0563200W. 30 NM arc centred at CRR VOR/ DME up to 342000S/0560000W. Straight line up to 342127S/0550546W. 30 NM arc from LDS VOR/DME up to the following points 345200S/0542900W, straight line up to 361000S/0542900W, straight line up to the following points 345900S/0565300W.</p> <p>CARRASCO CTR Circumference arc, radius 15 NM centred at 344957.8S 0560130.5W clockwise from 343511S/0560444W up to 350217S/0561158W, straight line up to 345534S/0562246W, CTR arc radius 10 NM (18.5 KM) centred at ASI NDB clockwise up to 343731S/0561754W and straight up to 343511S/0560444W, excluded ZOM 5 (if it is activated).</p> <p>CARRASCO ATZ Circle, radius 8 NM centred at 344957.8S 0560130.5W, excluded ZOM 5 (if it is activated)</p>
2	<i>Vertical limits</i>	TMA: GND up to FL 245. CTR: SFC up to FL 035. ATZ: SFC up to 600 M
3	<i>Airspace classification</i>	CTR, ATZ: C. TMA: G from GND up to 600 M; C above 600 M up to FL 195; A above FL 195 up to FL 245.
4	<i>ATS unit call sign Language(s)</i>	Carrasco Tower Spanish, english
5	<i>Transition altitude</i>	900 M
6	<i>Remarks</i>	Nil

SUMU AD 2.9-18 ATS COMMUNICATION FACILITIES

<i>Service designation</i>	<i>Call sign</i>	<i>Frequency</i>	<i>Hours of operation</i>	<i>Remarks</i>
1	2	3	4	5
ACC	Montevideo/ Radar Control	128.5 MHZ 126.3MHZ 121.5 MHZ*	H 24 H 24 H 24 H 24	Montevideo ACC accepted as secondary Air-Ground communication the telephone usage: (598) 2604 0295 * Emergency FREQ
APP/I	Carrasco Radar Approach	119.2 MHZ 120.2 MHZ	H 24 H 24	
TWR	Carrasco Tower	118.1 MHZ 121.8 MHZ	H 24 H 24	Nil Nil
AMS/AFS	Fuerza Aérea Carrasco CXJ	8315 KHZ 5610 KHZ	HJ - O/R HJ - O/R	Nil Nil

SUMU AD 2.9-19 RADIO NAVIGATION AND LANDING AIDS

<i>Type of aid, MAG VAR, Type of supported OP (for VOR/ILS/MLS, give declination)</i>	<i>ID</i>	<i>Frequency</i>	<i>Hours of operation</i>	<i>Position of transmitting antenna coordinates</i>	<i>Elevation of DME transmitting antenna</i>	<i>Remarks</i>
1	2	3	4	5	6	7
VOR/DME (8°W/2005)	CRR	116.9 MHZ	H24	344957.8S 0560130.5W	30 M/98 FT	Nil
ILS/LLZ Cat I	ICAR	109.9 MHZ	H24	345043.29S 0560232.12W	Nil	Nil
ILS GS			H24	344943.98S 0560102.83W	Nil	Touch point glide path (GP) located 394 m after the threshold of runway 25
DME 25			H24	345043.29S 0560232.12W	Nil	Nil
L	AR	260 KHZ	H24	344924.4S 0560022.6W	Nil	25 KM coverage
L	CA	280 KHZ	H24	344704.9S 0555636.3W	Nil	25 KM coverage
ILS/LLZ Cat I	IMVD	111.1 MHZ	H24	345041.64S 0560150.52W	Nil	Nil
ILS GS			H24	344928.49S 0560155.02W	Nil	Nil
DME 19			H24	345041.64S 0560150.52W	20 M/66 FT	Nil

SUMU AD 2.9-20 LOCAL TRAFFIC REGULATIONS

1. Delimitation and Jurisdiction Areas of "General Cesáreo L. Berisso" Carrasco Intl Airport

For the purposes of applying the rules governing the movement of people and vehicles in the "Cesáreo L. Berisso" Carrasco International Airport, it is divided into three areas:

- a) A **public area** comprised by those parts of the airport open to the public and where only in exceptional cases, the Aeronautic Authority may partly or fully limit the use of it.
- b) A **restricted area** comprised by the rest of the civil airport under the jurisdiction of the Aeronautic Authority.
- c) A **military area** comprised by those parts of the airport occupied by Brigada Aérea I and Brigada de Mantenimiento y Abastecimiento and facilities that is under military jurisdiction.

2. Movement of people and vehicles

2.1 We fully implemented AD 1.1-1. The entry and stay of individuals and vehicles in the restricted area is the responsibility of the Policía Aérea Nacional.

a) **Public Area**

People and vehicles access the Public Area of Carrasco International Airport, except when the Aeronautic Authority determines otherwise.

In any Public Area will comply with existing vehicular traffic rules, posted speed limits and parking will be made in specific areas for this purposes.

b) **Restricted Area**

- I) In all cases and without exception the aircraft take precedence over people and land vehicles.
- II) Where necessary the transit of persons in the Restricted Area, these have priority over the terrestrial vehicles.
- III) The maximum speed is 25 KM. per hour except in emergency cases affected with it.
- IV) Drivers of vehicles moving in any Restricted Area Carrasco International Airport must hold suitable driver license for the vehicle they drive and the Entry Permission issued by the competent Aviation Authority.
- V) Drivers must comply with the signalling within the restricted area and are subject at all times comply with the requirements of the Aviation Authority and airport operators.
- VI) Accidents within the Restricted Area must be brought to the attention of the Departamento de Operaciones of Carrasco International Airport immediately after the fact.
- VII) No trains with more than 5 luggage cars or 6 container cars can be towed.
- VIII) The loading and unloading of passengers carried by bus and by the use of fingers. In all cases disembarking take precedence over the boarding.
- IX) Vehicles circulating within the restricted area must have reglamentary lights and headlights right rotary during the 24 hours.

- X) It is prohibited entry into and movement through the taxiways and runways to all vehicles not equipped with a transmitter / receiver with control tower frequency. The responsables of the units must be instructed in the use of such equipment as well as the terms and phrases used in aerodrome control. In case of communications failure responsible for the vehicle shall comply with the control tower signals according to the following:

- Steady **GREEN** light: "authorized to move"
- Steady **RED** light: "stop the march"
- A series of **RED** flashes: "circulate away from the transit zone of Aircraft"
- A series of **WHITE** flashes: "return to the starting point of his vehicle"

It will be an indication of prohibition to enter to taxiways and runways, the lighting of the lights, demarcation of any of the runways, and taxiways.

- XI) It is prohibited the movement of vehicles on the taxiway that connects the Southwest platform with the South platform.

3. Taxiing to and from parking spaces

Any civilian or military aircraft parked and "engines off" that are available to leave this AD, must communicate with "Carrasco Tower" 118.1 MHZ (primary frequency) or 121.8 MHZ (secondary frequency), in order to obtain information from MET conditions, RWY in use, approval of FPL, SID, SSR code and scheduled DLY for engine start, and then communicate with "Carrasco Tower" 118.1 MHZ to receive control, information and alert service. The ACFT operating in platform only receive traffic information available.

CONTROL, COORDINATION AND SUPERVISION OF THE PLATFORM

The control, coordination and supervision of the platforms within the competence of the **Operations Management of the airport operator (Puerta del Sur SA)**. Such jurisdiction is excluded from the control or regulation of movement of aircraft in platforms, which will be governed as provided in Annex 2, Rules of the Air 3.2 Avoidance of collisions - 3.2.2.7 Movement of aircraft on the surface. The provisions of this part, tend to general users can perform the tasks inherent in the operation of aircraft with maximum security for it; it is necessary to strict compliance with the provisions set forth below:

- I) Users should in all cases, ask the Operations Management of the airport operator before the arrival of aircraft, the parking positions to use.
- II) The parking stands are marked according to international standards of autonomous parking of aircraft. Consequently, the ground staff instructions to aircraft will be based on tracking the guide lines for entering, forward rotation and indicator stop signal for the position.
The alterations that for operational reasons could result in changes to the aircraft parking must be authorized in advance by the Operations Management of the airport operator.
- III) The parking stands are intended for embarking and disembarking of passengers, cargo, mail, refuelling, routine tasks and system control parts of the aircraft.
Major maintenance tasks when they have to be done, shall first be coordinated with the Operations Management of the airport operator of the airport operator for the purposes concerned.

- IV) The operator is the responsible of parking stands were clean of oils and fuels and all types of waste that have been dumped during the operation of the aircraft.
- V) Aircrafts during parking, driveways and braking should be accordingly.
- VI) Prohibits the testing of engines in the parking stands.
- VII) Smoking is prohibited on the apron.
- VIII) The assistance of parking and towing of aircraft will be provided by the contractor in office.

Fuel load

- I) The maintenance and refuelling must be arranged by operators of aircraft with the fuel supply companies that provide services or maintenance, as appropriate.
- II) The fuel supply will be always in the position assigned to the aircraft parking.
- III) Refuelling is prohibited of any kind to any aircraft that keep their engines running.
- IV) During the refuelling tasks the supplying company shall place the earth connections, NO SMOKING signs for and have the fire fighting equipment according to International Standards.
- V) The refuelling with passengers on board will be made in accordance with the provisions of LAR 153/154 and Circular C.UY.AGA.002 A of DEC 2013 and in accordance with the provisions of the Operations Manual operating companies.

Responsibility

- I) Activities in the area of the platforms are controlled by the Operations Management of the airport operator and inspected by the competent authority.
- II) The entry and stay in the restricted area of the authorized vehicles will be the responsibility of the Policía Aérea (Air Police).
- III) For the purposes of compliance with section I and II above, the Operations Management of the airport operator and the Policía Aérea (Operations Department and Air Police) complement comptroller closely their tasks.

☛Manoeuvring areas for military and police helicopters

- ☛Areas are established as military and police helicopter manoeuvres in the "Cesáreo L. Berisso" Carrasco
- ☛International Airport the followings:

<i>Area</i>	<i>Location</i>
K	Lateral South of remote point Z, ex-TWY Echo and RWY intersection
L	Lateral North of remote point Z, 100 M North from remote point Z up to RWY 01/19
M	Lateral West TWY Charlie, RWY 01/19 and TWY Foxtrot

See "Helicopter Manoeuvre Areas"

For the above areas of operations, the following transit circuits are designated:

<i>Area</i>	<i>Traffic Circuits</i>
K, L	The traffic pattern will always be made South of remote point Z
M	The traffic pattern will always be made in the West of the runway 01/19

In both cases the height to use will vary between 600 and 1100 FT depending on the type of aircraft and the manoeuvre to be performed. These transits can be shortened to not interfere with the path of the runway 07/25 (on request Air Traffic Controller or Pilot in command) must carry out the exit turn from transit or turn before the basic path of runway 07/25, called this "Short Transit"

See "Helicopter Traffic Circuits"

Military Helicopters (Uruguayan Air Force - Air Squadron No. 5 and Police Helicopters (Ministerio del Interior – National Police Air Squadron)

Air taxi route is established from parking position to remote point Z

Civil Helicopters

Entry and exit from apron already in air or ground taxi will be conducted via taxiway C and / or taxiway A.

HELICOPTER MANOEUVRE AREAS

MONTEVIDEO/Intl
Carrasco "Gral.
Cesareo L. Berisso"

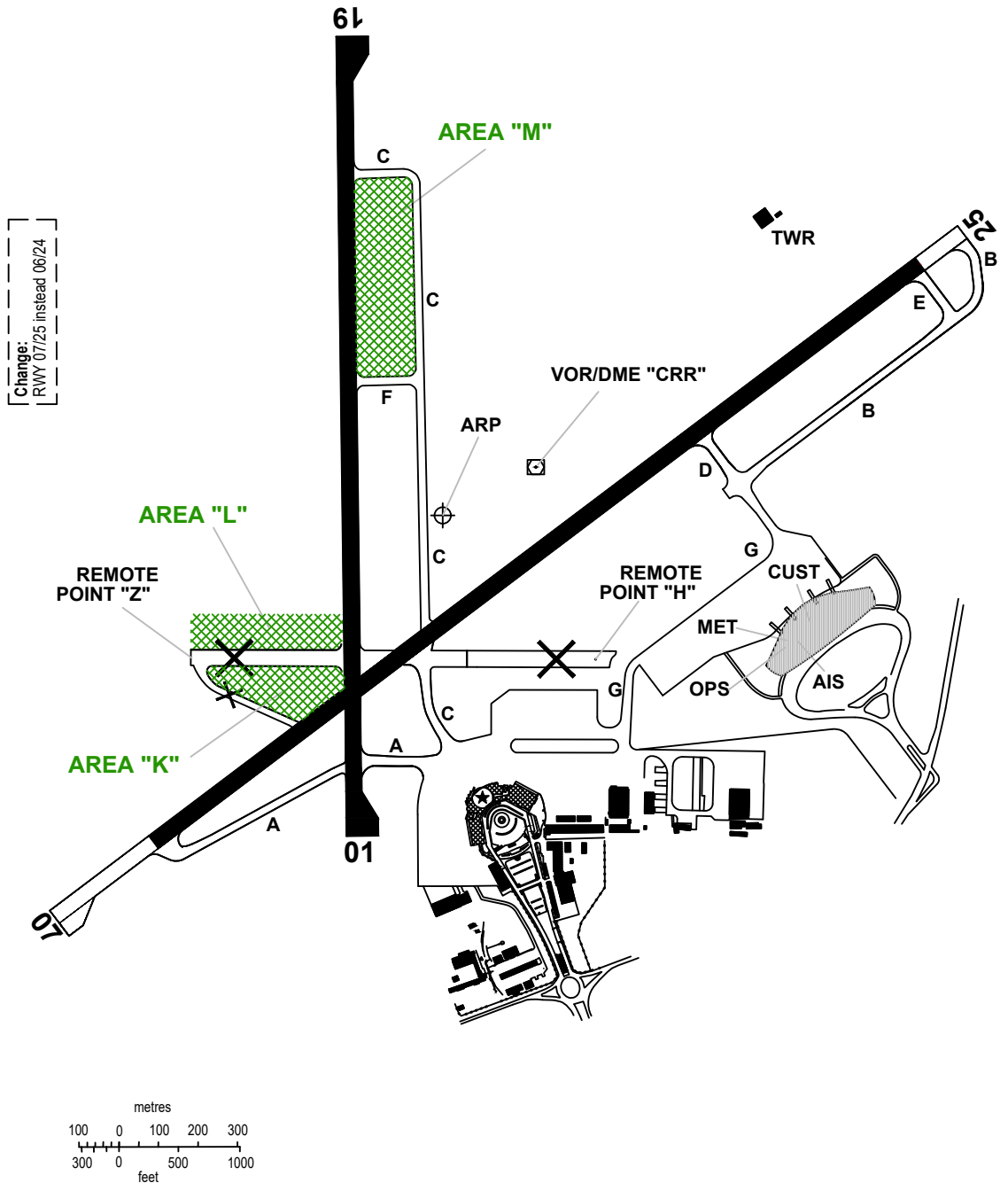

HELICOPTER TRAFFIC CIRCUITS

MONTEVIDEO/Intl
Carrasco "Gral.
Cesareo L. Berisso"

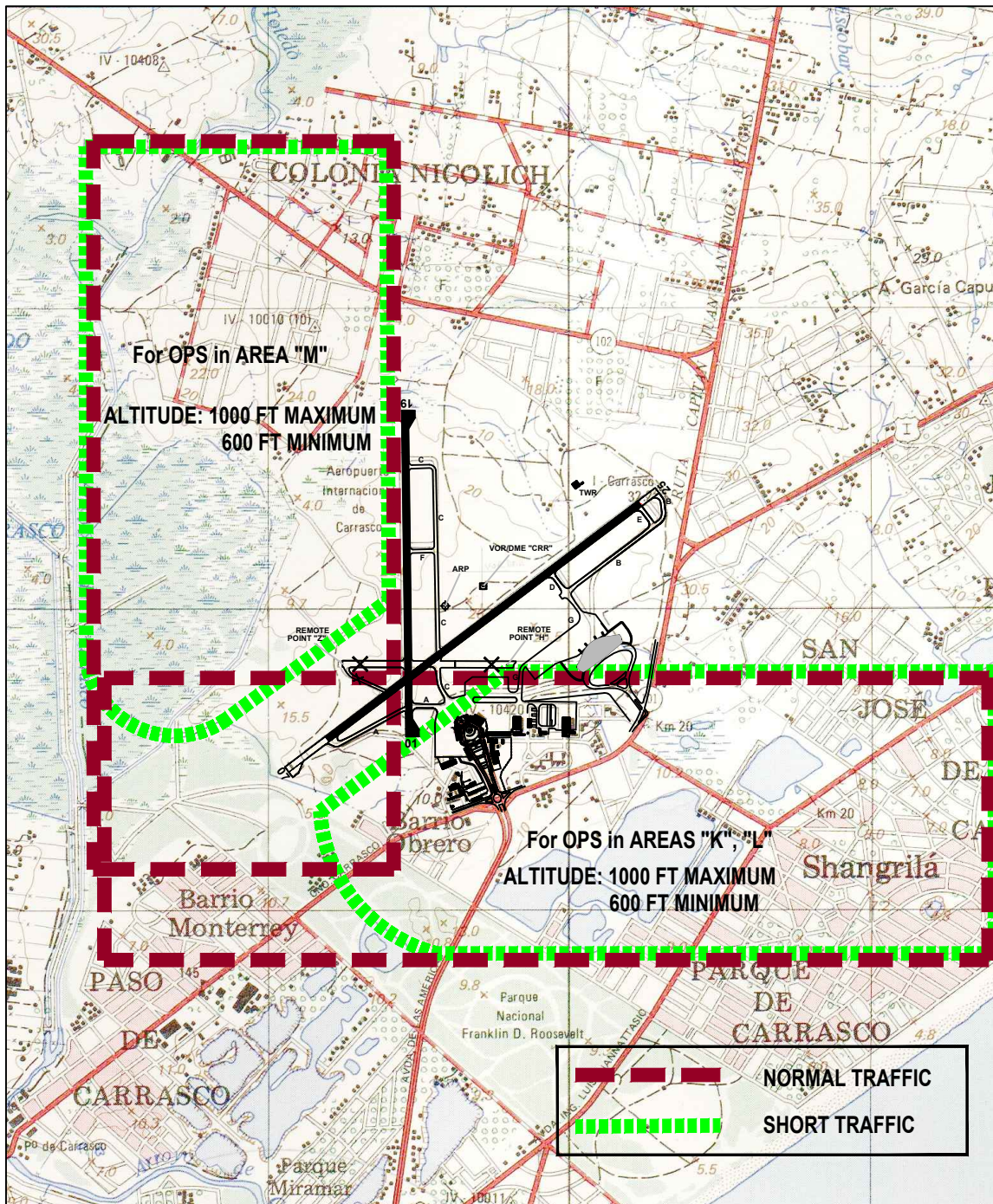

Change:
RWY 07/25 instead 06/24

4. Procedures for the operation of 747-8 aircraft

4.1 747-8F Landing:

- ☛ Landing on Runway 07: clear at TWY E, then TWY B to TWY D, then back taxi on Runway 25, clear at TWY C to TWY G to Aircraft Stand 12.
- ☛ Landing on Runway 25: 180° turn at runway and then back taxi on Runway 07, clear at TWY C to TWY G to Aircraft Stand 12.

4.2 747-8 (intercontinental) Landing:

- ☛ Landing on Runway 07: clear at TWY E, then TWY B to TWY D, to Aircraft Stand 32 to 35, as assigned.
- ☛ Landing on Runway 25: 180° turn at runway and then back taxi on Runway 07, clear at TWY D to Aircraft Stand 32 to 35, as assigned.

4.3 747-8F Take off:

- ☛ Take off on Runway 07: from Aircraft Stand, follow TWY G to TWY C, then back taxi Runway 25 to runway end, then perform 180° turn for take off.
- ☛ Take off on Runway 25: from Aircraft Stand, follow TWY G to TWY C, then back taxi Runway 07, clear at TWY D to TWY E to TWY B, then hold short of Runway 25 for take off.

4.4 747-8 (intercontinental) Take off:

- ☛ Take off on Runway 07: from Aircraft Stand, follow TWY D, then back taxi Runway 25 to runway end, then perform 180° turn for take off.
- ☛ Take off on Runway 25: from Aircraft Stand, follow TWY D to TWY B, then hold short of Runway 25 for take off.

4.5 Parking:

For 747-8F: Aircraft Stand 12 in Commercial Apron II.

For 747-8 (intercontinental): Aircraft Stands 32 to 35 in Commercial Apron I.

4.6 Remarks:

747-8F aircraft taxiing to/from Aircraft Stand 12 via TWY G will have reduced wingtip clearance of 8.3 M clearance if aircraft are parked on Aircraft Stands 9 to 11. This portion of TWY G is treated as a taxilane. Maintain taxi speed at 12 KT or less.

Airport fillets designed for A340-600.

Follow-me vehicle available con request.

SUMU AD 2.9-21 NOISE ABATEMENT PROCEDURES

Diurnal takeoffs that proceed to fly over the city of Montevideo, shall apply the noise abatement procedures of each aircraft in take-off of all the runways, especially runway 25 and 19.

At night take-offs are not allowed to fly over the city of Montevideo, between 21:00 and 07:00 local time except for emergency, traffic reasons and / or weather.

The direct approach aircrafts flying over the city of Montevideo, shall maintain 3000 FT (900 M) up to 10 NM DME arc, proceeding then to descend to land, except for emergency, reasons of traffic, weather or the aircraft is conducting a published instrument procedures to runway 07.

Restrictions on the landing runway 07.

Both during the instrument approach, as in visual approaches are not allowed to fly below the minimum for runway 07 procedures.

SUMU AD 2.9-22 FLIGHT PROCEDURES

Overview

Flights within the Carrasco TMA will be in accordance with instrument flight rules or visual as appropriate.

Procedures for IFR flights within the TMA CARRASCO:

Approach routes, transit and departure indicated in the charts can be modified at the discretion of ATC. Unless ATC considers necessary other alternative, aircraft flying within a TMA below FL 100 shall maintain an indicated maximum speed of 250 KTS.

Procedures for VFR flights within the TMA CARRASCO:

If permitted traffic conditions, it will be given ATC clearance for VFR flights in the conditions described below:

- a) There will be a FPL to request ATC clearance containing 7 to 18 points and which indicates the purpose of the flight.
- b) ATC clearance shall be obtained immediately before the aircraft enters the area concerned.
- c) Position reports shall be submitted in accordance with paragraphs 3.6.3 of ICAO Annex 2.
- d) Only possible to deviate from an ATC clearance has been obtained when permission.
- e) The flight was conducted with vertical visual reference to ground unless it can be made in accordance with instrument flight rules.
- f) Maintain two-way radio communication in frequency 120.2, 119.2 CARRASCO APP.
- g) The aircraft will be equipped with SSR Mode C transponders

Note: ATC authorization is intended to provide separation between IFR and VFR.

Minimum vertical separation in the Traffic Circuit of Carrasco.

Nil.

Radar procedure within the CARRASCO TMA.

Vector and Sequencing Guide

Aircraft entering the Carrasco TMA shall be sequenced to the corresponding published final approach path to ensure rapid and orderly traffic flow.

• The aircraft will be guided directly to the initial approach fix (IAF) or final approach fix (FAF), or as coordinated with the aerodrome control to a point or section of the visual circuit.

Vectors and levels / altitudes of flight will be provided, if necessary, to achieve a spacing between aircrafts to maintain an appropriate interval in the landing, taking into account the characteristics of them.

IFR takeoff minimums

The minimum applicable for takeoff in terms of ceiling and visibility, for aircrafts with two or more engines, shall be the minimum expected for the published instrument approach procedure for the runway in use.



The minimum applicable for takeoff in terms of ceiling, for single-engine aircrafts shall be equal to or greater than that established in the instrument approach charts and the minimum visibility required shall be 1600 M.

☛ On runways with a 1-minute RVR reading, this reading prevails over the value published in the METAR/SPECI.

☛ Reduction of IFR takeoff minimums from runway 07/25 (threshold 25)

☛ Applies only to aircraft with two or more engines:

☛ Minimum RVR visibility 550 M, with the RVR value prevailing over the value published in the METAR/SPECI.

☛ 1) For takeoff with reduced visibility minima, it is required an alternate aerodrome post-launch in box 18 of Flight Plan Form located within the following distances:

☛ a) twin-engine aircraft: alternated one hour of flight at cruising speed with one engine out of service in ISA atmosphere and windless atmospheric conditions.

☛ b) three or more aircraft engines: alternated to two hours of flight at cruising speed with all engines running, in ISA atmosphere and windless atmospheric conditions.

☛ Note 1: Indicate the alternate aerodrome post-launch as follows:

RMK / DEP ALTN (4 letters Aerodrome location indicator)

☛ Note 2: Fill in the forms of Repetitive Flight Plan in the box Q "Remarks"

☛ 2) MET conditions for the alternate aerodrome post-launch.

The alternate aerodrome post-launch shall at least be operational for IFR landings at the time of takeoff and forecasts indicate that conditions will be at or above minimum values using the aerodrome at the expected time of landing.

☛ 3) IFR minimum flight level

The aircraft must be able to climb with one engine inoperative until the IFR flight level appropriate to proceed to the alternate aerodrome post-takeoff or destination aerodrome.

IFR landing minimums

The minimum necessary for landing in terms of ceiling and visibility, shall be the minimum for the instrumental approach procedure published for the runway in use.

Holding procedures, approach, and departure

Holding procedures and approach that is published are based on standards set in the latest edition of DOC.8168-OPS/611 (PANS / OPS) of ICAO "Procedures for Air Navigation Services, Aircraft Operations."

Arriving flights

✈ IFR flights entering a TMA to land shall be routed to the corresponding published final approach path and those indicated by the respective control according to the conditions in the area.

Departing flights

✈ IFR flights departing from controlled aerodromes shall receive an initial permission from the ATC of the Aerodrome Service (TWR or AFIS); the limit of such permission shall normally be the destination aerodrome.

✈ After takeoff, the turns and paths that the aircraft shall follow, as well as the levels that they must maintain before reaching the assigned cruising level, shall be those indicated in the air traffic control permit.

Holding procedure

Holding procedures are indicated in each case in the instrument approach charts.

If for some reason had to do a holding procedure at one point for has not been published any, it will be make a normal holding procedure, forming a hippodrome-type circuit, according to the procedure recommended in Doc 8168-OPS / 611, VOL I, Part IV of ICAO

The aircrafts shall enter holding patterns at speeds equal to or less than the following.

See ENR 1.5-2

Communications Failure

In case of communication failure, the pilot shall act in accordance with LAR 91, 91.265 (b) and LAR 211, 211 6.3.2.

SUMU AD 2.9-23 ADDITIONAL INFORMATION

Procedure for Domestic Flights

The crew must complete the Sworn Statement of Domestic Flights (2 copies), which may be obtained at the website of the Carrasco Intl Airport (www.aerpuertodecarrasco.com.uy), at the Operations Offices of rest airports of the country or at the Custom Office of the Arrivals Hall.

From the aircraft parked on the apron it shall move the occupants of it to the doors of the Arrivals Hall of the Terminal.

If it is required, it must be submitted the Sworn Statement of Domestic Flights to the Migration authority, indicating that it is a domestic arrival.

The occupants of the aircraft must direct towards the Customs checkpoint, but are unable to make purchases at the Duty Free Shop.

It shall submit a copy of the Sworn Statement of Domestic Flights (copy 1) in a position of Customs, indicating that it is a domestic arrival. Sanitary Barrier staff performs the appropriate actions if they required.

The crew must submit a copy of the Sworn Statement of Domestic Flights (copy 2) in the Office of Airport Flight Plan.

☛ Attractive areas and presence of birds in the vicinity of the airport

☛ Caution is advised in aircraft operations in the sector located southwest of Carrasco International Airport, 3.8 NM (6.1 KM) from the VOR / DME "CRR" (34°49'57.8"S 056°01'30.5"W) RDL 252, due to the presence of birds, in particular gulls (*Larus dominicanus*) due to the existence of a final waste disposal plant (34°51'05"S 056°05'29"W). The movements of the seagulls between the coast and the mentioned final waste disposal plant are carried out, mainly during the first three hours after sunrise and two hours before sunset. The route followed by the birds to and from the plant comprises a corridor of variable width. The flights of these birds are at low altitude, varying according to atmospheric conditions.

☛ In addition, other land uses are recognized as relevant and attractive for fauna were identified in their environment as potential feeding, roosting and / or refuge sites, mainly for birds, as they are the major sources of conflict with airport operations. These land uses are: wetlands, crops and water bodies (see Bird Concentrations).

☛ Presence of birds at the airport

☛ Generally, due to the occurrence of rains, the presence of marine and coastal birds such as: terns (*Sternae*), kelp gulls (*Larus dominicanus*), brown-hooded gull (*Larus maculipennis*) is found in the airport property.

☛ Study about birds

☛ According to information from the Carrasco Airport Bird and Fauna Control staff, 205 species were recorded in the vicinity of the airport property.

☛ Four categories are established in Advisory Circular CA-AGA-153-006 that group the registered birds according to their body mass:

- Category 0: body mass between 0 and 249 grams, represented by 144 species
- Category 1: body mass between 250 and 749 grams, represented by 35 species
- Category 2: body mass between 750 and 1499 grams, represented by 17 species: roseate spoonbill, red-headed raven, caravan, biguá, carao, great coot, lobster harrier, kelp gull, white-tailed eagle, great white heron, martineta, mixed hawk, red heron, witch heron, red eagle, peregrine falcon, cinnamon duck.
- Category 3, body mass of more than 1,500 grams, represented by 9 species: black-necked swan, chaja, coscoroba, common stork, black heron, creole duck (domesticated), black eagle, yellow bandurria, black bandurria.

☛ Among the species registered at the airport, those with category 2 and 3 stand out due to their relevance and potential risk.

☛ According to the impact registration statistics, the following species stand out:

- Tero (*Vanellus chilensis*).
- Kelp gull (*Larus dominicanus*)
- Pigeons (Genus *Columba* and *Patagioenas*)
- Carancho (*Caracara plancus*)
- Common falcon (*Falco sparverius*)

Bird and Wildlife Control Program

☛ The prevention and dispersion methods used to mitigate the risk of impacts or ingestions are based on the use of biological control with falconry techniques, dispersal with harassing dogs, pyrotechnic launching system, placement of traps for mammals, the routes movement area and biological studies.

Service coverage

From 10:00 to 22:00 UTC by the Bird and Wildlife Control company.

☛ From 22:00 to 10:00 UTC by the Operations & Experience Management of the Airport Operator.

☛ Ibis bird strike notification

☛ Whenever events related to Impacts or intakes of Fauna occur with the aircraft, it must be delivered; one copy of the IBIS report to the Office of Commercial Air Transport Inspectors at Carrasco International Airport and another to the Operations & Experience Management of the Airport Operator.

Special taxiing operations for category "E" or higher aircraft.

• It is established as runway holding position for threshold 07 the one located over taxiway "A" prior to the crossing to runway 01-19, for category "E" or higher aircrafts.

SUMU AD 2.9-24 CHARTS RELATED TO AN AERODROME

Aerodrome/Heliport Chart – ICAO RWY 01/19.....	AD 2.9-27
☛ Aerodrome/Heliport Chart – ICAO RWY 07/25.....	AD 2.9-29
Aerodrome Ground Movement Chart – ICAO.....	AD 2.9-31
Aircraft Parking/Docking Chart – ICAO.....	AD 2.9-33
Aerodrome Obstacle Chart – ICAO Type A (RWY 01/19).....	AD 2.9-35
☛ Aerodrome Obstacle Chart – ICAO Type A (RWY 07/25).....	AD 2.9-37
☛ Instrument Approach Chart - ICAO ILS Y or LOC ONLY Y RWY 19	AD 2.9-39
☛ Instrument Approach Chart - ICAO ILS Y or LOC ONLY Y RWY 25	AD 2.9-41
☛ Instrument Approach Chart - ICAO ILS Z RWY 19	AD 2.9-43
☛ Instrument Approach Chart - ICAO ILS Z RWY 25	AD 2.9-45
☛ Instrument Approach Chart - ICAO RNP Z RWY 01	AD 2.9-47
☛ Instrument Approach Chart - ICAO RNP Z RWY 07	AD 2.9-49
☛ Instrument Approach Chart - ICAO RNP Z RWY 19	AD 2.9-51
☛ Instrument Approach Chart - ICAO RNP Z RWY 25	AD 2.9-53
☛ Instrument Approach Chart - ICAO VOR Z RWY 07	AD 2.9-55
☛ Instrument Approach Chart - ICAO VOR Z RWY 25	AD 2.9-57
☛ ATC Surveillance Minimum Altitude Chart - ICAO.....	AD 2.9-59
☛ Bird concentrations in the vicinity of aerodromes.....	AD 2.9-61

AERODROME/HELIPORT
CHART - ICAO

34°50'02"S ELEV 32
056°01'41"W (105)

TWR 118.1 - 121.8
APRON 000.0

MONTEVIDEO/Int'l
Carrasco "Gral.
Cesareo L. Berisso"

TAXIWAYS 23 WIDE

ELEVATIONS IN METRES (AND FEET)
DIMENSIONS IN METRES
BEARINGS ARE MAGNETIC

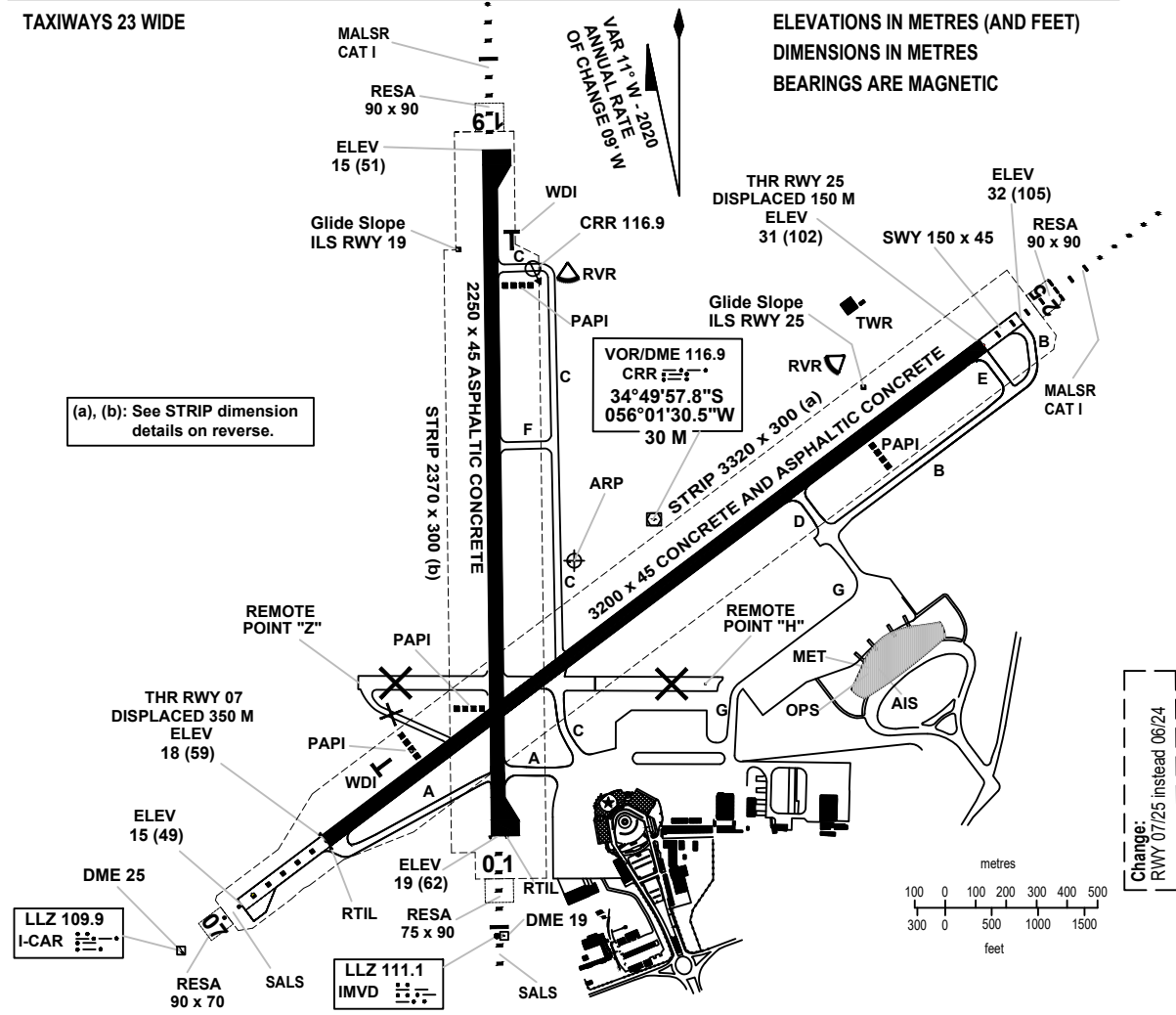

MARKING AIDS RWY 01/19 AND EXIT TWY



LIGHTING AIDS RWY 01/19 AND EXIT TWY

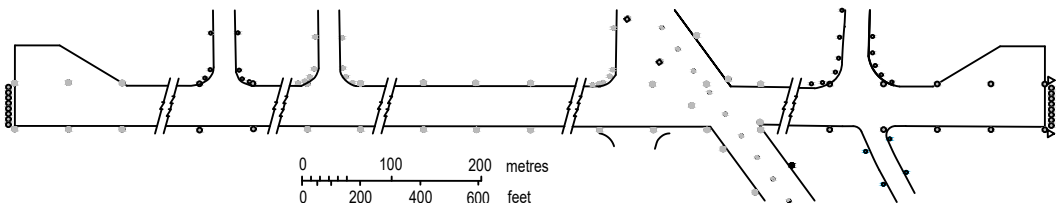

AERODROME/HELIPORT
CHART - ICAO

34°50'02"S ELEV 32
056°01'41"W (105)

TWR 118.1 - 121.8
APRON 000.0

MONTEVIDEO/Int'l
Carrasco "Gral.
Cesareo L. Berisso"

TAXIWAYS 23 WIDE

ELEVATIONS IN METRES (AND FEET)
DIMENSIONS IN METRES
BEARINGS ARE MAGNETIC

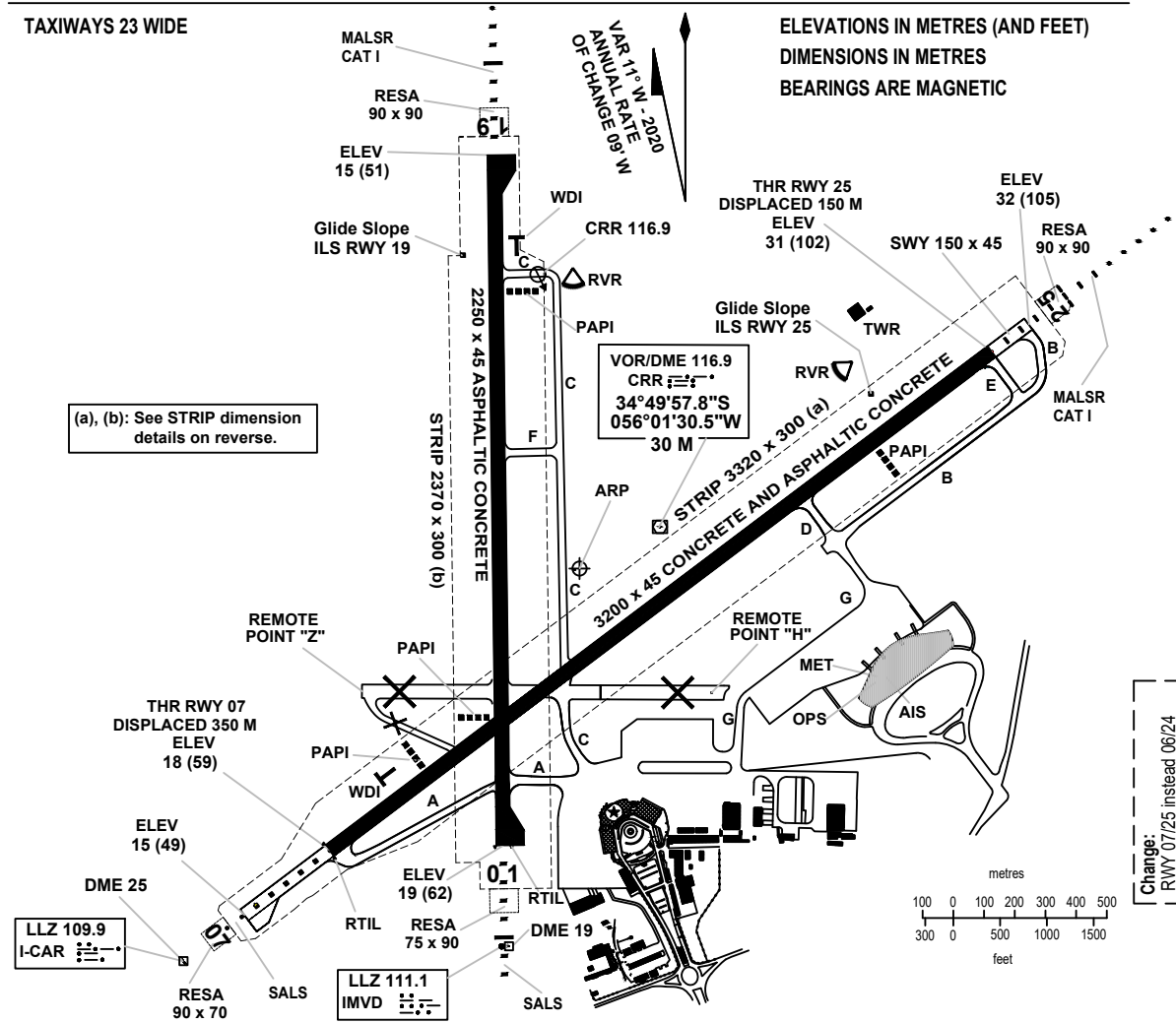

MARKING AIDS RWY 07/25 AND EXIT TWY

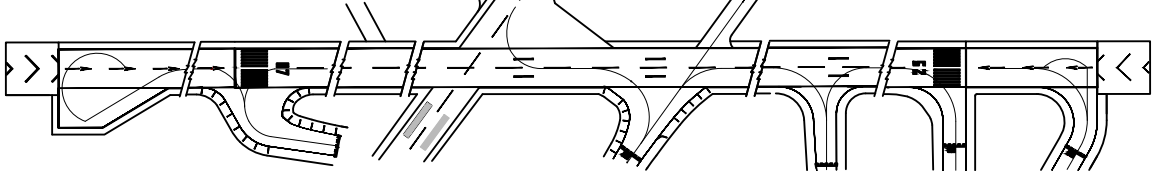

LIGHTING AIDS RWY 07/25 AND EXIT TWY

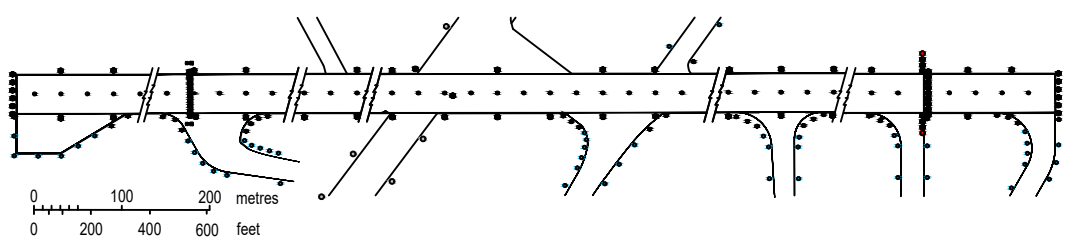

AERODROME/HELIPORT
CHART - ICAO

34°50'02"S
056°01'41"W **ELEV 32**
(105)

TWR 118.1 - 121.8
APRON 000.0

MONTEVIDEO/Int'l
Carrasco "Gral.
Cesareo L. Berisso"

RWY	DIRECTION	THR	GUND	BEARING STRENGTH
07	065°	34°50'31.64"S 56°02'12.96"W	14.0 M	Runway PCN 88/F/C/W/U
25	245°	34°49'39.56"S 56°00'47.49"W	14.0 M	
01	010°	34°50'31.09"S 56°01'50.65"W	14.0 M	Runway PCN 55/F/C/W/T
19	190°	34°49'18.08"S 56°01'51.56"W	14.0 M	
Taxiway "A".				PCN 88/F/C/W/U
Taxiway "B" BTN Taxiway "D" and Runway 25				PCN 82/R/C/X/U PCN 88/F/C/W/U
Taxiway "C" BTN Runway 07-25 and APRON.				PCN 88/F/C/W/U
Taxiway "C" BTN Runway 07-25 and Runway 01-19.				PCN 40/F/C/X/T
Taxiway "D".				PCN 82/R/C/X/U
Taxiway "E".				PCN 88/F/C/W/U
Taxiway "F".				PCN 23/F/C/X/T
Taxiway "G".				PCN 82/R/C/X/U
Commercial I APRON				PCN 82/R/C/X/U
Commercial II APRON				PCN 82/R/C/X/U PCN 88/F/C/W/U
APRON SouthEast				PCN 23/F/C/X/T
Remote Point "H"		34°50'15.18"S 056°01'24.14"W		
Remote Point "Z"		34°50'14.70"S 056°02'08.59"W		

Cambio:
RWY 07/25 instead 06/24

<p>RWY 07 Strip -- Right side: Firsts 43 M - width 62 M increasing up to 84 M; next 373 M - width 84 M; next 239 M - width 84 M increasing up to 150 M; next 2631 M - width 150 M; rest (34 M) - 150 M decreasing up to 118 M.</p> <p>-- Left side: Firsts 265 M - width 72 M; next 199 M - width 72 M increasing up to 150 M; rest (2856 M) - width 150 M</p>
<p>RWY 25 Strip -- Right side: Firsts 2856 M - width 150 M; next 199 M - width 150 M decreasing up to 72 M; rest (265 M) - width 72 M.</p> <p>-- Left side: Firsts 34 M - width 118 M increasing up to 150 M, next 2631 M - width 150 M; next 239 M - width 150 M decreasing up to 84 M; next 373 M - width 84 M; rest (43 M) - width 84 M decreasing up to 62 M.</p>
<p>RWY 01 Strip -- Right side: Firsts 1974 M - width 150 M; next 39 M - width 150 M decreasing up to 77 M; rest (357 M) - width 77 M.</p> <p>-- Left side: Firsts 84 M - width 75 M; next 1911 M - width 150 M; rest (375 M) - width 113 M.</p>
<p>RWY 19 Strip -- Right side: Firsts 375 M - width 113 M; next 1911 M - width 150 M; rest (84 M) - width 75 M.</p> <p>-- Left side: Firsts 357 M - width 77 M; next 39 M - width 77 M increasing up to 150 M; rest (1974 M) - width 150 M.</p>

AERODROME GROUND
MOVEMENT CHART - ICAO

APRON ELEV
15 (49)

TWR 118.1 - 121.8
APRON 000.0

MONTEVIDEO/Intl
Carrasco "Gral.
Cesareo L. Berisso"

ELEVATIONS IN METRES (AND FEET)
DIMENSIONS IN METRES
BEARINGS ARE MAGNETIC

TAXIWAY EDGE LIGHTS
ON ALL TAXIWAYS ELEV
15 (51)

AUTH 180° TURN FOR
HEAVY ACFT ON
RWY ENDS 07, 01 AND 19

TAXIWAYS 23 WIDE

VAR 11° W 2020
ANNUAL RATE
OF CHANGE 0.9 'W

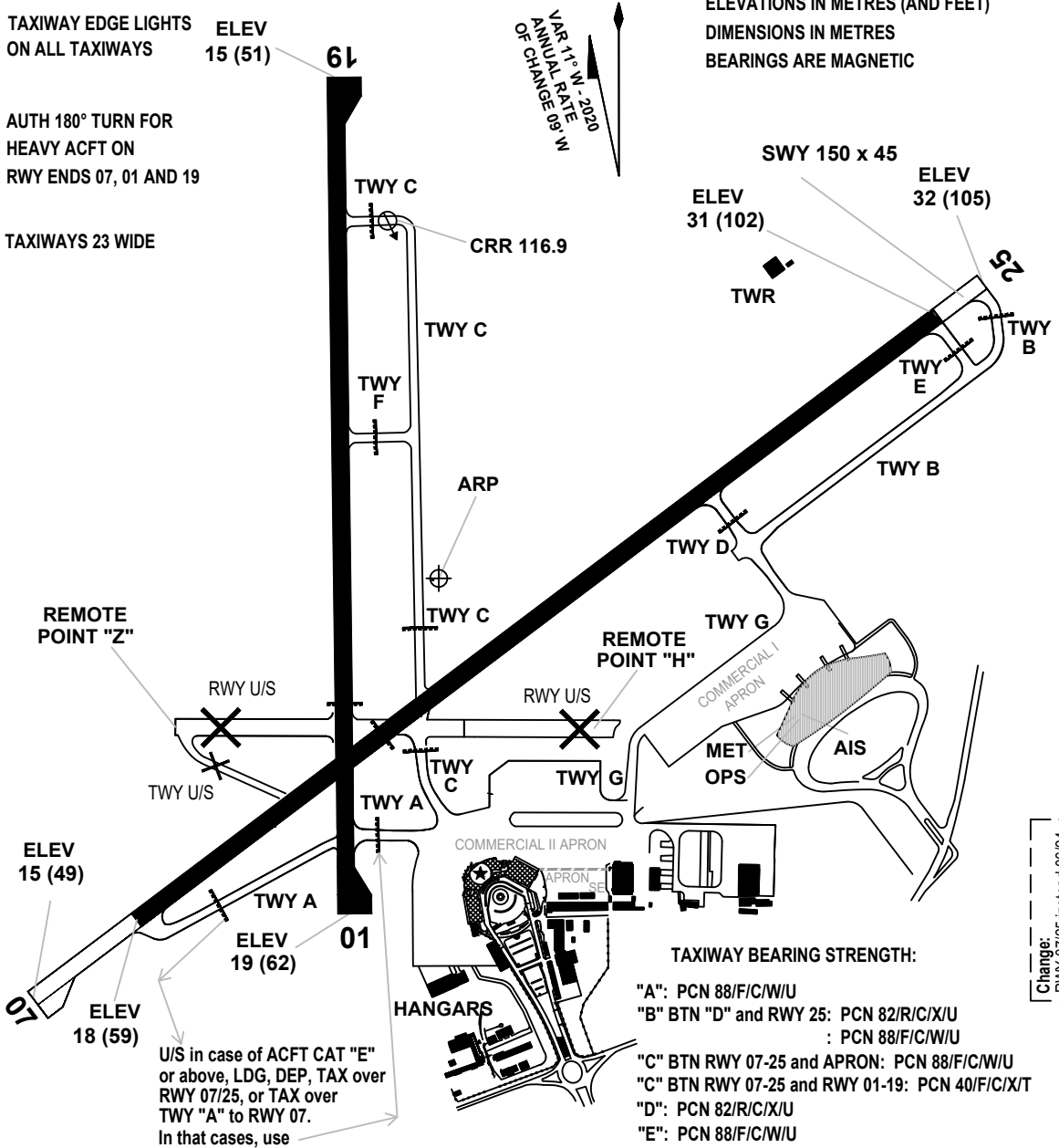

TAXIWAY BEARING STRENGTH:

- "A": PCN 88/F/C/W/U
- "B" BTN "D" and RWY 25: PCN 82/R/C/X/U
: PCN 88/F/C/W/U
- "C" BTN RWY 07-25 and APRON: PCN 88/F/C/W/U
- "C" BTN RWY 07-25 and RWY 01-19: PCN 40/F/C/X/T
- "D": PCN 82/R/C/X/U
- "E": PCN 88/F/C/W/U
- "F": PCN 23/F/C/X/T
- "G": PCN 82/R/C/X/U
- Commercial I Apron PCN 82/R/C/X/U
- Commercial II Apron PCN 82/R/C/X/U, 88/F/C/W/U
- APRON SE PCN 23/F/C/X/T

Change:
RWY 07/25 instead 06/24

**INTENTIONALLY
LEFT BLANK**

AIRCRAFT PARKING/
DOCKING CHART - ICAO

APRON ELEV
15 (49)

TWR 118.1 - 121.8
APRON 000.0

MONTEVIDEO/Intl
Carrasco "Gral.
Cesareo L. Berisso"

ELEVATIONS IN MÈTRES (AND FEET)
DIMENSIONS IN MÈTRES
BEARINGS ARE MAGNETIC

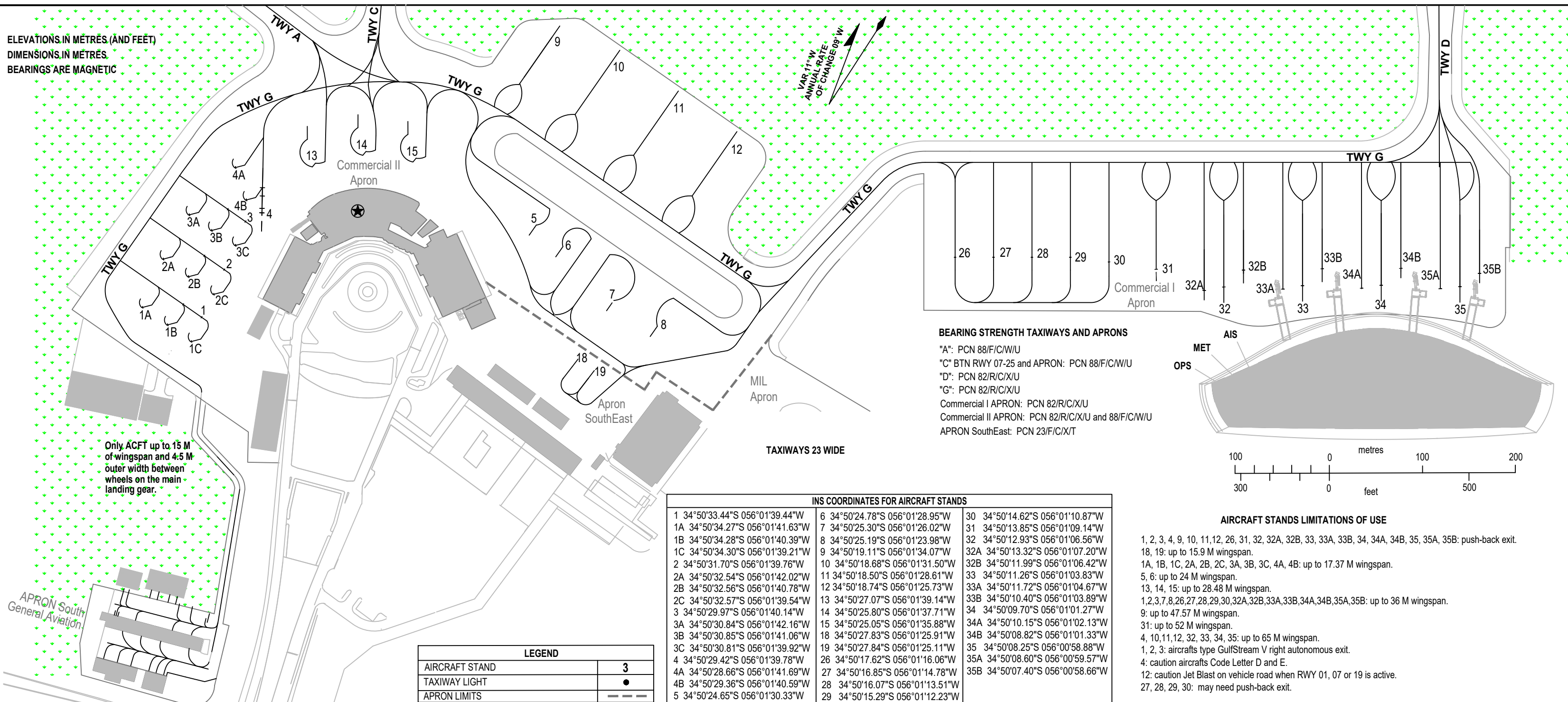
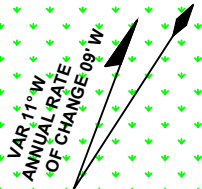

Only ACFT up to 15 M of wingspan and 4.5 M outer width between wheels on the main landing gear.

APRON South General Aviation

BEARING STRENGTH TAXIWAYS AND APRONS

- "A": PCN 88/F/C/W/U
- "C" BTN RWY 07-25 and APRON: PCN 88/F/C/W/U
- "D": PCN 82/R/C/X/U
- "G": PCN 82/R/C/X/U
- Commercial I APRON: PCN 82/R/C/X/U
- Commercial II APRON: PCN 82/R/C/X/U and 88/F/C/W/U
- APRON SouthEast: PCN 23/F/C/X/T

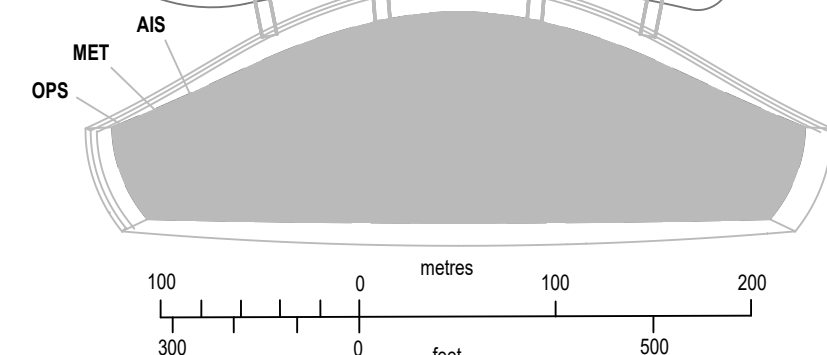

AIRCRAFT STANDS LIMITATIONS OF USE

- 1, 2, 3, 4, 9, 10, 11, 12, 26, 31, 32, 32A, 32B, 33, 33A, 33B, 34, 34A, 34B, 35, 35A, 35B: push-back exit.
- 18, 19: up to 15.9 M wingspan.
- 1A, 1B, 1C, 2A, 2B, 2C, 3A, 3B, 3C, 4A, 4B: up to 17.37 M wingspan.
- 5, 6: up to 24 M wingspan.
- 13, 14, 15: up to 28.48 M wingspan.
- 1, 2, 3, 7, 8, 26, 27, 28, 29, 30, 32A, 32B, 33A, 33B, 34A, 34B, 35A, 35B: up to 36 M wingspan.
- 9: up to 47.57 M wingspan.
- 31: up to 52 M wingspan.
- 4, 10, 11, 12, 32, 33, 34, 35: up to 65 M wingspan.
- 1, 2, 3: aircrafts type GulfStream V right autonomous exit.
- 4: caution aircrafts Code Letter D and E.
- 12: caution Jet Blast on vehicle road when RWY 01, 07 or 19 is active.
- 27, 28, 29, 30: may need push-back exit.

TAXIWAYS 23 WIDE

INS COORDINATES FOR AIRCRAFT STANDS

1 34°50'33.44"S 056°01'39.44"W	6 34°50'24.78"S 056°01'28.95"W	30 34°50'14.62"S 056°01'10.87"W
1A 34°50'34.27"S 056°01'41.63"W	7 34°50'25.30"S 056°01'26.02"W	31 34°50'13.85"S 056°01'09.14"W
1B 34°50'34.28"S 056°01'40.39"W	8 34°50'25.19"S 056°01'23.98"W	32 34°50'12.93"S 056°01'06.56"W
1C 34°50'34.30"S 056°01'39.21"W	9 34°50'19.11"S 056°01'34.07"W	32A 34°50'13.32"S 056°01'07.20"W
2 34°50'31.70"S 056°01'39.76"W	10 34°50'18.68"S 056°01'31.50"W	32B 34°50'11.99"S 056°01'06.42"W
2A 34°50'32.54"S 056°01'42.02"W	11 34°50'18.50"S 056°01'28.61"W	33 34°50'11.26"S 056°01'03.83"W
2B 34°50'32.56"S 056°01'40.78"W	12 34°50'18.74"S 056°01'25.73"W	33A 34°50'11.72"S 056°01'04.67"W
2C 34°50'32.57"S 056°01'39.54"W	13 34°50'27.07"S 056°01'39.14"W	33B 34°50'10.40"S 056°01'03.89"W
3 34°50'29.97"S 056°01'40.14"W	14 34°50'25.80"S 056°01'37.71"W	34 34°50'09.70"S 056°01'01.27"W
3A 34°50'30.84"S 056°01'42.16"W	15 34°50'25.05"S 056°01'35.88"W	34A 34°50'10.15"S 056°01'02.13"W
3B 34°50'30.85"S 056°01'41.06"W	18 34°50'27.83"S 056°01'25.91"W	34B 34°50'08.82"S 056°01'01.33"W
3C 34°50'30.81"S 056°01'39.92"W	19 34°50'27.84"S 056°01'25.11"W	35 34°50'08.25"S 056°00'58.88"W
4 34°50'29.42"S 056°01'39.78"W	26 34°50'17.62"S 056°01'16.06"W	35A 34°50'08.60"S 056°00'59.57"W
4A 34°50'28.66"S 056°01'41.69"W	27 34°50'16.85"S 056°01'14.78"W	35B 34°50'07.40"S 056°00'58.66"W
4B 34°50'29.36"S 056°01'40.59"W	28 34°50'16.07"S 056°01'13.51"W	
5 34°50'24.65"S 056°01'30.33"W	29 34°50'15.29"S 056°01'12.23"W	

LEGEND	
AIRCRAFT STAND	3
TAXIWAY LIGHT	●
APRON LIMITS	---

[Change: [RWY 07/25 instead 06/24]

**INTENTIONALLY
LEFT BLANK**

AERODROME OBSTACLE CHART - ICAO TYPE A (OPERATING LIMITATIONS)

MONTEVIDEO/Intl Carrasco "Gral. Cesáreo L. Berisso"

DIMENSIONS AND ELEVATIONS IN METRES

MAGNETIC VARIATION 11° W JAN 2020

RWY 01 / 19

DECLARED DISTANCES

RWY 01		RWY 19
2250	TAKE-OFF RUN AVAILABLE	2250
2250	TAKE-OFF DISTANCE AVAILABLE	2250
2250	ACCELERATE STOP DISTANCE AVAILABLE	2250
2250	LANDING DISTANCE AVAILABLE	2250

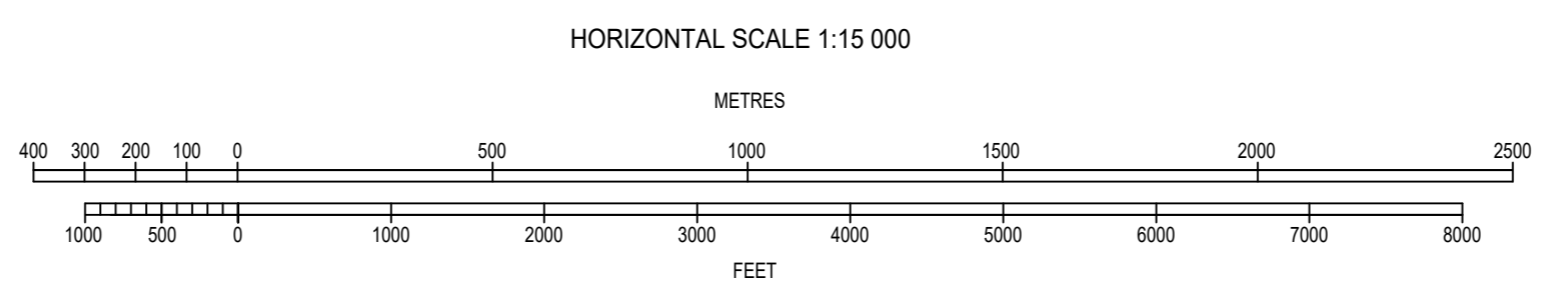
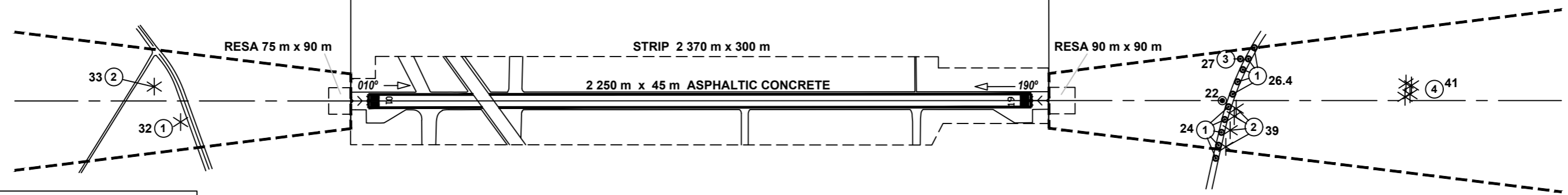
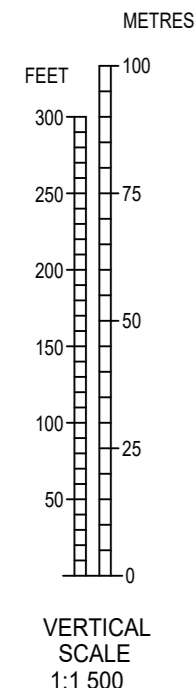
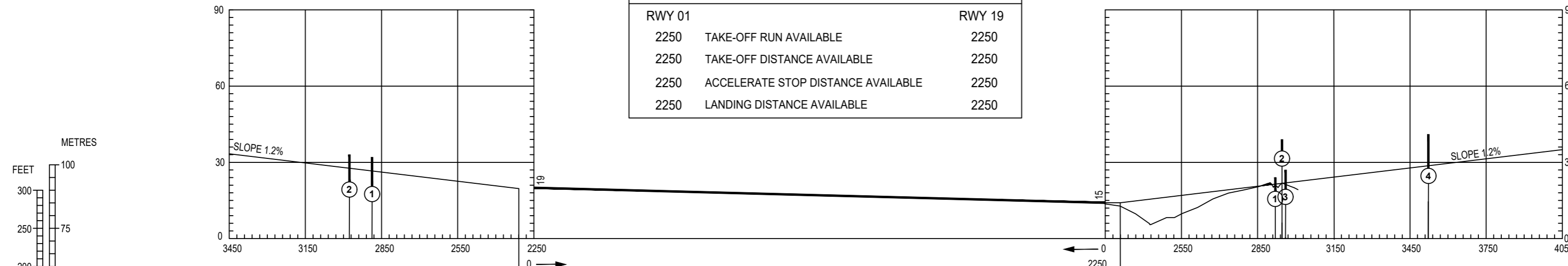

LEGEND	
IDENTIFICATION NUMBER	①
TREE OR SHRUB	*
HIGHWAY	====
POLE, TOWER, SPIRE, ANTENNA, ETC.	⊙
BUILDING OR LARGE STRUCTURE	■
RAILROAD	—+—+—+—
TERRAIN CONTOUR	~
TERRAIN PENETRATING OBSTACLE PLANE	⌒

ORDER OF ACCURACY
HORIZONTAL 00 M
VERTICAL 00 M

Change: Magnetic variation

**INTENTIONALLY
LEFT BLANK**

AERODROME OBSTACLE CHART - ICAO

TYPE A (OPERATING LIMITATIONS)

DIMENSIONS AND ELEVATIONS IN METRES

MONTEVIDEO/Intl Carrasco "Gral. Cesáreo L. Berisso"

MAGNETIC VARIATION 11° W JAN 2020

RWY 07 / 25

DECLARED DISTANCES

RWY 07		RWY 25
3050	TAKE-OFF RUN AVAILABLE	3200
3200	TAKE-OFF DISTANCE AVAILABLE	3200
3200	ACCELERATE STOP DISTANCE AVAILABLE	3200
2700	LANDING DISTANCE AVAILABLE	3050

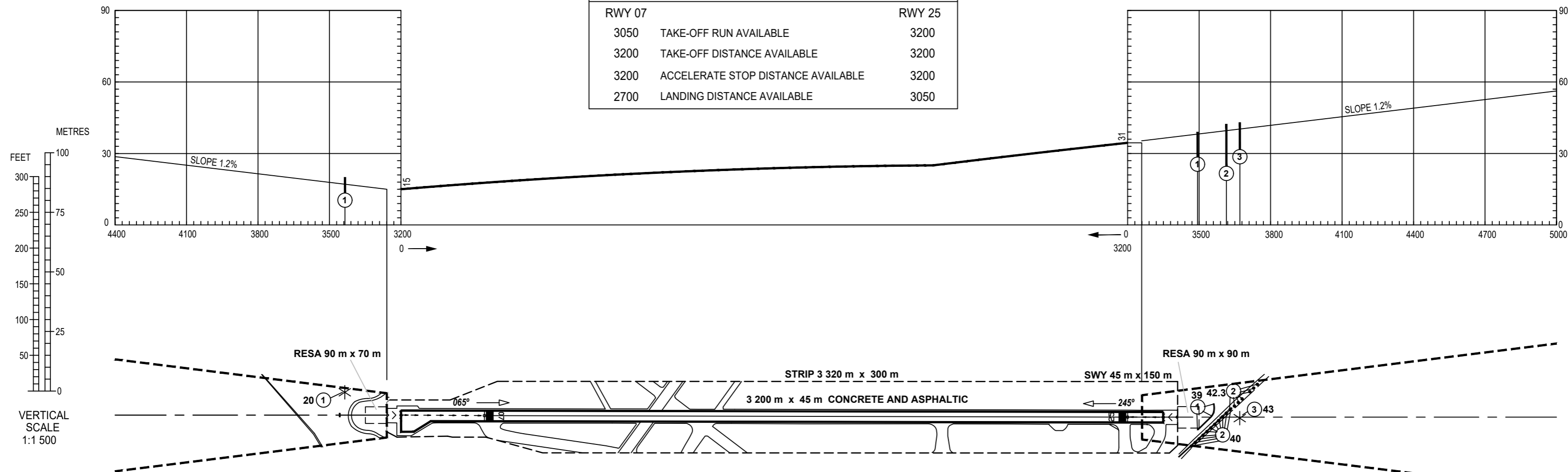

LEGEND	
IDENTIFICATION NUMBER	①
TREE OR SHRUB	*
HIGHWAY	====
POLE, TOWER, SPIRE, ANTENNA, ETC.	⊙
BUILDING OR LARGE STRUCTURE	■
RAILROAD	—+—+—+—
TERRAIN CONTOUR	~ ~ ~
TERRAIN PENETRATING OBSTACLE PLANE	▲▲▲

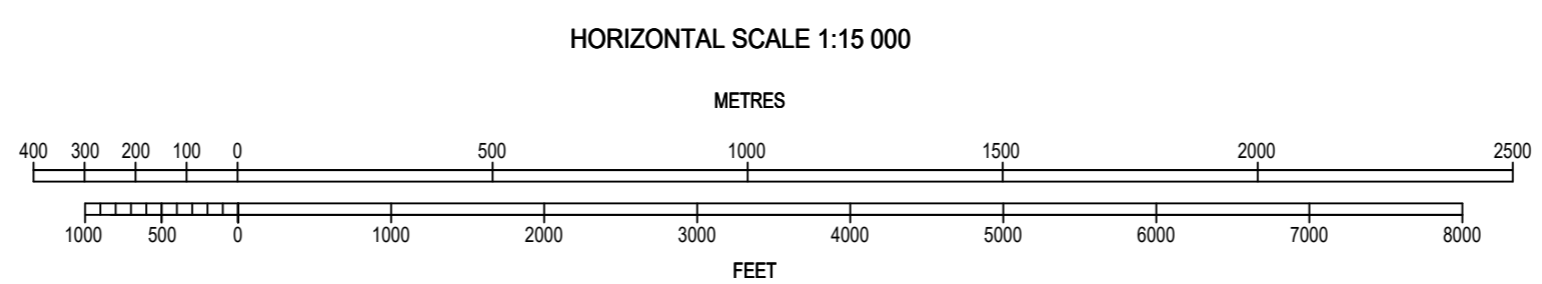

ORDER OF ACCURACY
HORIZONTAL 00 M
VERTICAL 00 M

Change: RWY 07/25 instead 06/24

**INTENTIONALLY
LEFT BLANK**

INSTRUMENT
APPROACH
CHART - ICAO

AERODROME ELEV **105 FT**
HEIGHTS RELATED TO
THR RWY 19 - ELEV 51 FT

TWR 118.1 - 121.8
APP 119.2 - 120.2

MONTEVIDEO/Intl
Carrasco "Gral. Av. Cesáreo L. Berisso"
ILS Y or LOC ONLY RWY 19

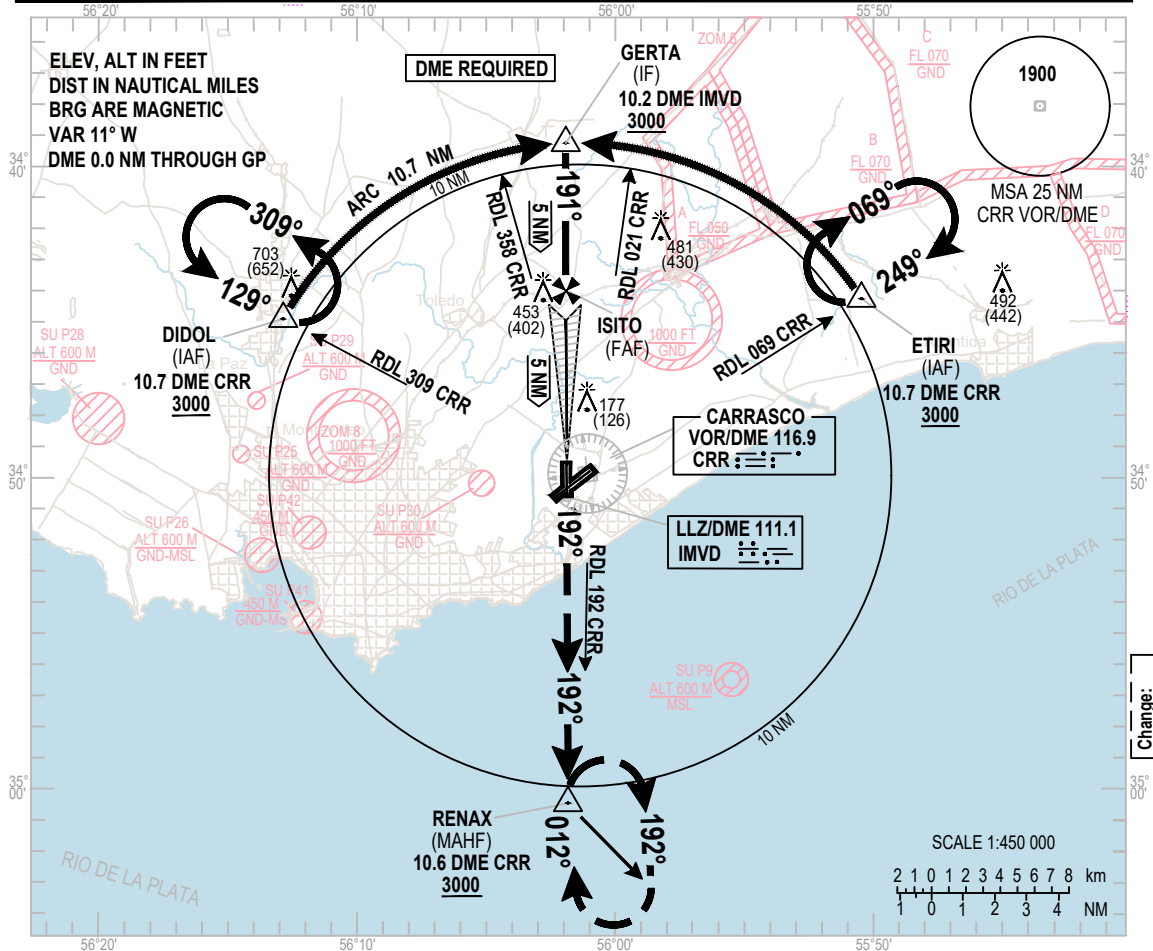

MISSED
APPROACH

NOTE:
4.4% of MNM missed approach gradient,
established by airspace.

ILS RDH 53

TRANSITION ALT 3000

Climb up to 3000 FT with
heading 192° to intercept
RDL 192 "CRR" VOR/DME
and hold in RENAX.

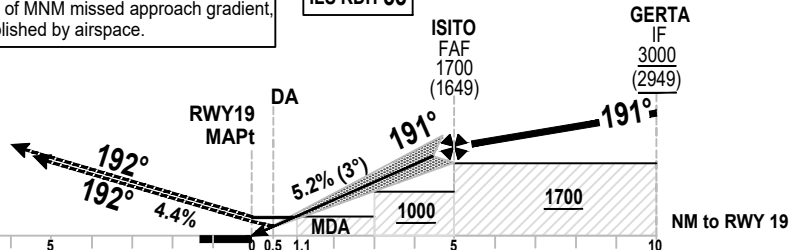

(THR RWY 19)

OCA/H		A	B	C	D			KT	90	110	130	150	170
Straight-in Approach	ILS/DME	251(200)				ISITO - RWY19 (5 NM)		Feet/ Min					
	VIS	RVR 750 M - 1200 M ALS INOP				Vertical speed of descent 5.2%			450	550	650	750	850
	LOC/DME	460(409)				NM RWY 19		5	4	3	2	1.1	0.5
	VIS	1100 M - 1800 M ALS INOP				Altitude Height		1700	1383	1064	746	460	251
								1655	1328	1009	691	409	200

INSTRUMENT
APPROACH
CHART - ICAO

AERODROME ELEV **105 FT**
HEIGHTS RELATED TO
THR RWY 19 - ELEV 51 FT

TWR 118.1 - 121.8
APP 119.2 - 120.2

MONTEVIDEO/Intl
Carrasco "Gral. Av.
Cesáreo L. Berisso"
ILS Y or LOC ONLY Y RWY 19

AERONAUTICAL DATA TABULATION

ILS Y or LOC ONLY Y approach to RWY 19 from DIDOL or ETIRI	
Fix / Point	Coordinates
DIDOL (IAF)	34°44'56.40"S 056°12'56.36"W
ETIRI (IAF)	34°44'17.48"S 055°50'31.98"W
GERTA (IF)	34°39'17.11"S 056°01'57.72"W
ISITO (FAF)	34°44'17.59"S 056°01'54.64"W
CRR VOR/DME	34°49'57.8"S 056°01'30.5"W
MU001 (FTP) (LTP)	34°49'18.08"S 056°01'51.56"W
RWY19	34°49'18.08"S 056°01'51.56"W
IMVD (LOC)	34°50'41.64"S 056°01'50.52"W
RENAX (MAHF)	35°00'32.19"S 056°01'43.22"W

Change:
New chart

INSTRUMENT
APPROACH
CHART - ICAO

AERODROME ELEV **105 FT**
HEIGHTS RELATED TO
THR RWY 25 - ELEV 102 FT

TWR 118.1 - 121.8
APP 119.2 - 120.2

MONTEVIDEO/Intl
Carrasco "Gral. Av. Cesáreo L. Berisso"
ILS Y or LOC ONLY Y RWY 25

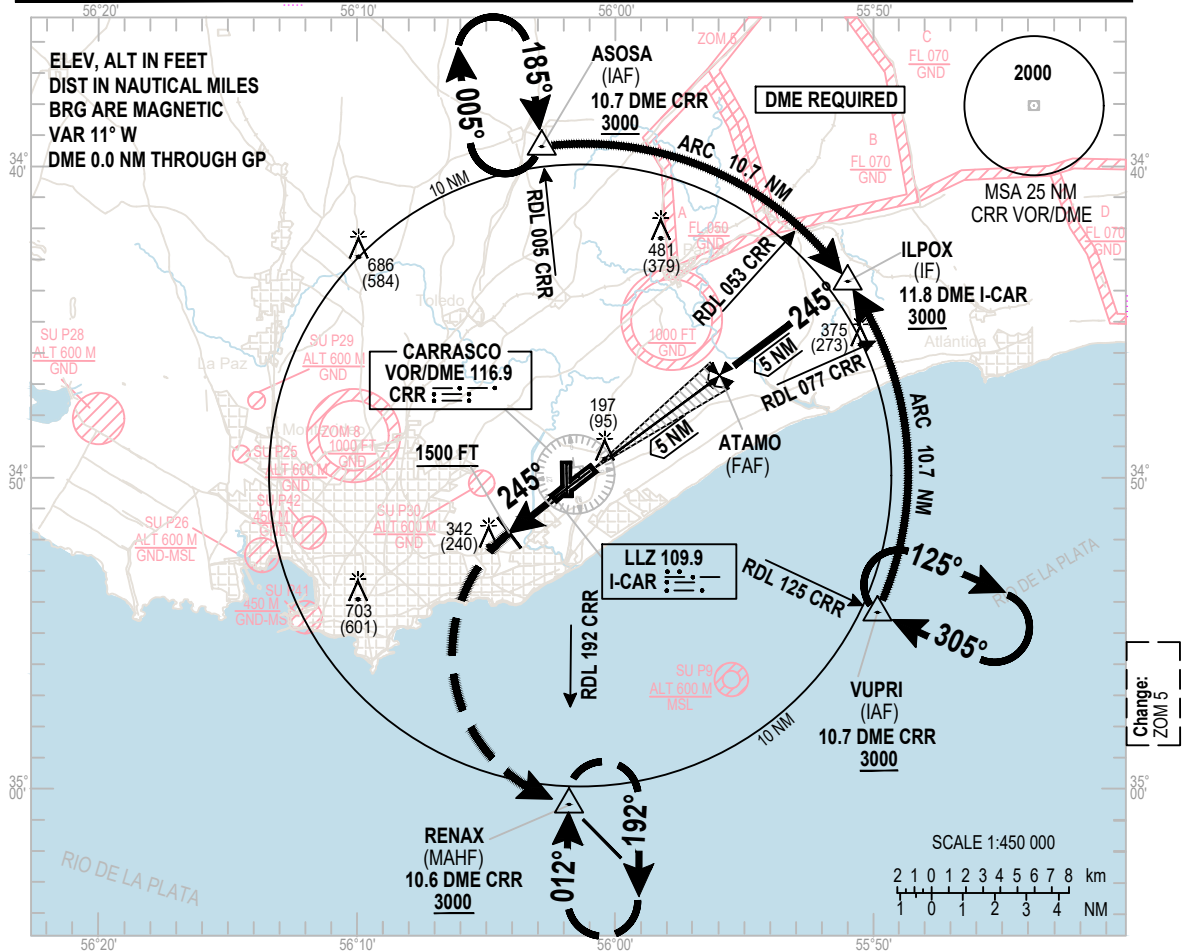

MISSED APPROACH
Climb up to 3000 FT:
heading 245° up to 1500 FT
turn left ascending
to RENAX for hold.

NOTE:
5% of missed approach gradient
up to 1500 FT by airspace.

ILS RDH 53 **TRANSITION ALT 3000**

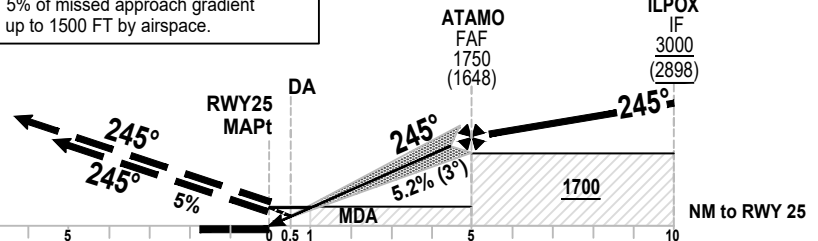

		OCA/H											
		A	B	C	D								
Straight-in Approach	ILS	302 (200)											
	VIS	RVR 750 M - 1200 M ALS INOP											
	LOC ONLY	800 M - 1200 M ALS INOP											
	VIS	480(378)											
		1000 M - 1700 M ALS INOP											
						ATAMO - RWY25 (5 NM)							
						Vertical speed of descent 5,2%	Feet/Min	90	110	130	150	170	
								450	550	650	750	850	
						NM RWY 25							
								5	4	3	2	1	0.5
						Altitude Height							
								1750	1432	1113	795	480	302
								1648	1327	1008	690	378	200

INSTRUMENT
APPROACH
CHART - ICAO

AERODROME ELEV **105 FT**
HEIGHTS RELATED TO
THR RWY 25 - ELEV 102 FT

TWR 118.1 - 121.8
APP 119.2 - 120.2

MONTEVIDEO/Intl
Carrasco "Gral. Av.
Cesáreo L. Berisso"
ILS Y or LOC ONLY Y RWY 25

AERONAUTICAL DATA TABULATION

ILS Y or LOC ONLY Y approach to RWY 25 from ASOSA or VUPRI	
Fix / Point	Coordinates
ASOSA (IAF)	34°39'20.76"S 056°02'49.81"W
VUPRI (IAF)	34°54'18.98"S 055°49'41.07"W
ILPOX (IF)	34°43'42.08"S 055°51'01.97"W
ATAMO (FAF)	34°46'40.92"S 055°55'54.55"W
CRR VOR/DME	34°49'57.8"S 056°01'30.5"W
RENAX (MAHF)	35°00'32.19"S 056°01'43.22"W
ICAR (LOC)	34°50'43.29"S 056°02'32.12"W
MAPT (FTP) (LTP)	34°49'39.56"S 056°00'47.49"W
RWY25	34°49'39.56"S 056°00'47.49"W

Change:
New chart

INSTRUMENT
APPROACH
CHART - ICAO

AERODROME ELEV **105 FT**
HEIGHTS RELATED TO
THR RWY 19 - ELEV 51 FT

TWR 118.1 - 121.8
APP 119.2 - 120.2

MONTEVIDEO/Intl
Carrasco "Gral. Av. Cesáreo L. Berisso"
ILS Z RWY 19

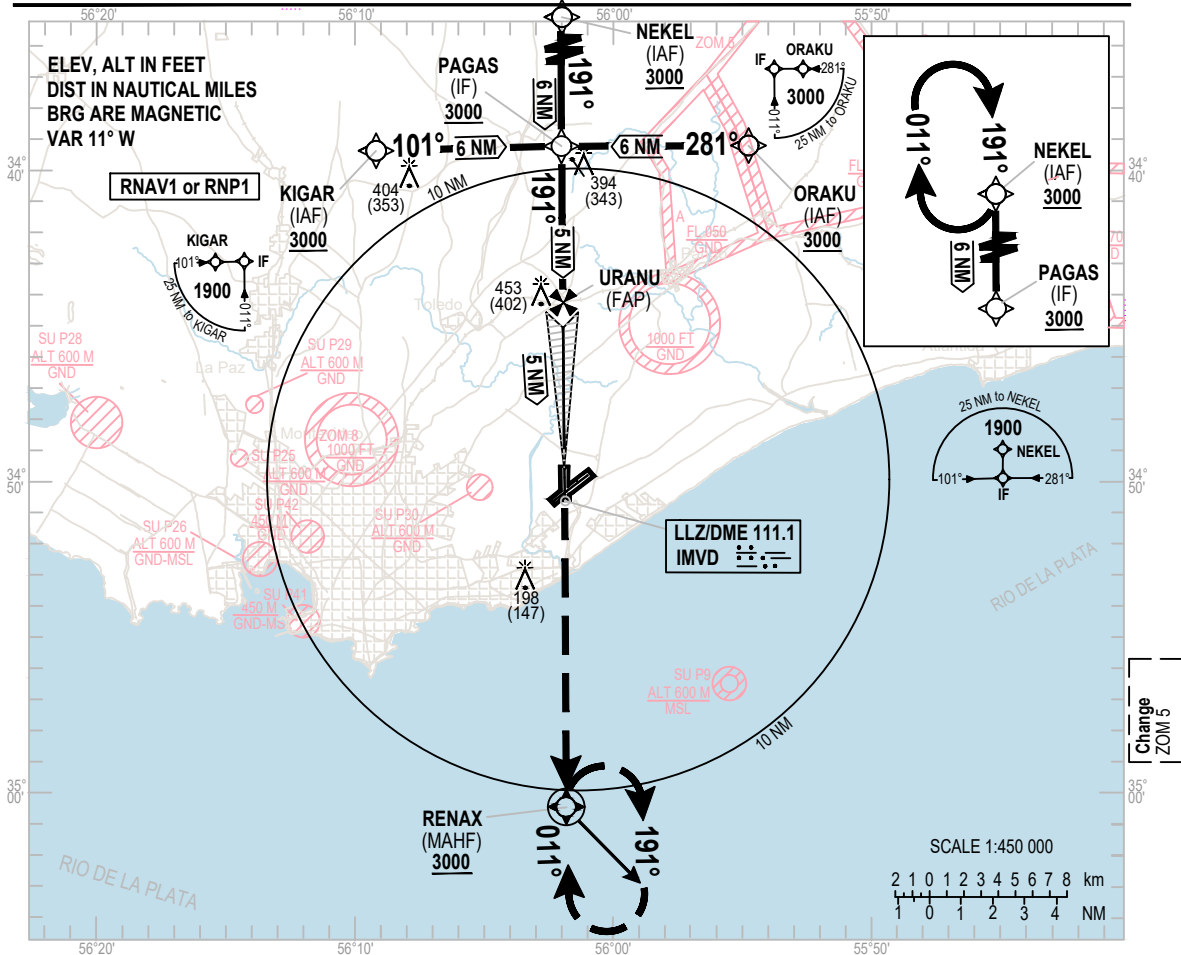

MISSED
APPROACH
**Climb up to 3000 FT
direct to RENAX
for hold.
MAX IAS 230KT.**

NOTE:
4.4% of MNM missed approach gradient,
established by airspace.

TRANSITION ALT 3000

ILS RDH 53

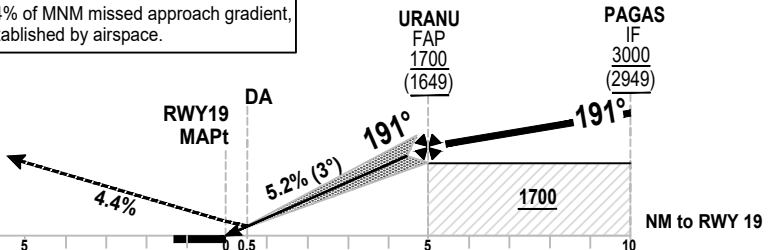

(THR RWY 19)

OCA/H	A	B	C	D	KT	80	100	120	140	160	180	
						Feet/Min	450	550	650	750	850	1000
Straight-in Approach	ILS	251(200)										
	VIS	RVR 750 M - 1200 M ALS INOP 800 M - 1200 M ALS INOP										
URANU - RWY19 (5 NM)												
Vertical speed of descent 5.2%												
NM RWY 19					5	4	3	2	1	0.5		
Altitude Height					1700	1380	1061	743	424	251	200	
					1649	1329	1010	692	373	200		

INSTRUMENT
APPROACH
CHART - ICAO

AERODROME ELEV **105 FT**
HEIGHTS RELATED TO
THR RWY 19 - ELEV 51 FT

TWR 118.1 - 121.8
APP 119.2 - 120.2

MONTEVIDEO/Intl
Carrasco "Gral. Av. Cesáreo L. Berisso"
ILS Z RWY 19

TABULAR DESCRIPTION

ILS Z RWY 19											
Serial Number	Path Descriptor	Waypoint Identifier	Fly-Over	Course °M(°T)	Magnetic Variation	Distance (NM)	Turn Direction	Altitude (FT)	Speed Limit (Knots/h)	VPA/TCH	Navigation Specification
010	IF	NEKEL	-	-	-	-	-	+3000	-	-	RNP APCH
020	TF	PAGAS	-	191(179.4)	-	6	-	+3000	-	-	RNP APCH
010	IF	KIGAR	-	-	-	-	-	+3000	-	-	RNP APCH
020	TF	PAGAS	-	101(089.5)	-	6	-	+3000	-	-	RNP APCH
010	IF	ORAKU	-	-	-	-	-	+3000	-	-	RNP APCH
020	TF	PAGAS	-	281(269.3)	-	6	-	+3000	-	-	RNP APCH
010	IF	PAGAS	-	-	-	-	-	+3000	-	-	RNP APCH
020	CF	URANU	-	191(179.4)	-	5	-	+1700	-	-3°	RNP APCH
030	CF	RWY19	Yes	191(179.4)	-	5	-	@106	-	3.0°(55FT)	RNP APCH
040	TF	RENAX	Yes	-	-	11.2	-	+3000	IAS 230	-	RNP APCH
050	HM	RENAX	Yes	011(359.5)	-	-	R	+3000	IAS 230	-	RNP APCH

Change:
Nueva carta

WAYPOINT LIST

ILS Z RWY 19	
Waypoint Identifier	Coordinates
NEKEL	34°33'16.53"S 056°02'03.50"W
KIGAR	34°39'20.57"S 056°09'15.40"W
ORAKU	34°39'13.23"S 055°54'42.68"W
PAGAS	34°39'17.12"S 056°01'59.03"W
URANU	34°44'17.60"S 056°01'55.30"W
RWY19	34°49'18.08"S 056°01'51.56"W
IMVD (LLZ)	34°50'41.64"S 056°01'50.52"W
RENAX	35°00'32.19"S 056°01'43.22"W

INSTRUMENT
APPROACH
CHART - ICAO

AERODROME ELEV **105 FT**
HEIGHTS RELATED TO
THR RWY 25 - ELEV 102 FT

TWR 118.1 - 121.8
APP 119.2 - 120.2

MONTEVIDEO/Intl
Carrasco "Gral. Av. Cesáreo L. Berisso"
ILS Z RWY 25

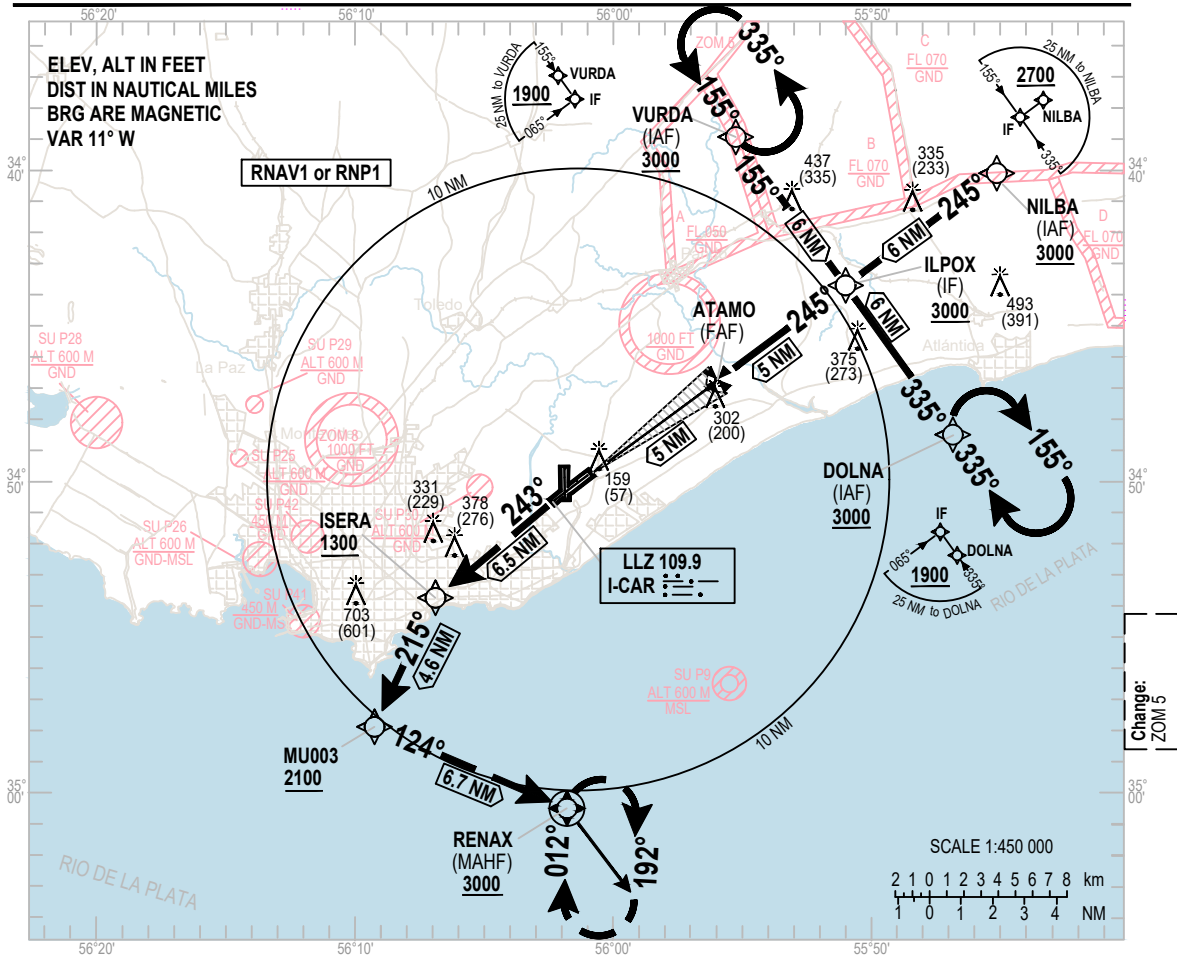

MISSED
APPROACH

NOTE:
3.3% of MNM missed approach gradient,
up to 2100 FT, established by airspace.

Climb up to 3000 FT:
heading 243° to ISERA, cross with
1300 FT or superior, then heading 215°
to MU003, cross with 2100 FT or
superior, then heading 124° at
RENAX for hold.

ELEV 102
(THR RWY 25)

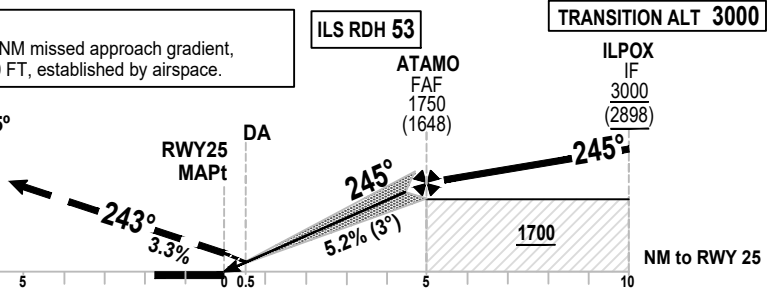

OCA/H		A	B	C	D	KT						
Straight-in Approach	ILS	302 (200)				80	100	120	140	160		
	VIS	RVR 750 M - 1200 M ALS INOP 800 M - 1200 M ALS INOP				Vertical speed of descent 5.2%						
						Feet/Min	450	550	650	750	850	
						NM RWY 25	5	4	3	2	1.0	0.5
						Altitude	1750	1375	1056	740	470	302
						Height	1648	1273	954	638	368	200

INSTRUMENT
APPROACH
CHART - ICAO

AERODROME ELEV **105 FT**
HEIGHTS RELATED TO
THR RWY 25 - ELEV 102 FT

TWR 118.1 - 121.8
APP 119.2 - 120.2

MONTEVIDEO/Intl
Carrasco "Gral. Av. Cesáreo L. Berisso"
ILS Z RWY 25

TABULAR DESCRIPTION

ILS Z RWY 25											
Serial Number	Path Descriptor	Waypoint Identifier	Fly-Over	Course °M(°T)	Magnetic Variation	Distance (NM)	Turn Direction	Altitude (FT)	Speed Limit (Knots/h)	VPA/TCH	Navigation Specification
010	IF	NILBA	-	-	-	-	-	+3000	-	-	RNP APCH
020	TF	ILPOX	-	245(233.3)	-	6	-	+3000	-	-	RNP APCH
010	IF	VURDA	-	-	-	-	-	+3000	-	-	RNP APCH
020	TF	ILPOX	-	155(143.5)	-	6	-	+3000	-	-	RNP APCH
010	IF	DOLNA	-	-	-	-	-	+3000	-	-	RNP APCH
020	TF	ILPOX	-	335(232.5)	-	6	-	+3000	-	-	RNP APCH
010	IF	ILPOX	-	-	-	-	-	+3000	-	-	RNP APCH
020	TF	ATAMO	-	245(233.4)	-	5	-	+1750	-	-3°	RNP APCH
040	TF	RWY25	Yes	245(233.5)	-	5	-	@155	-	-3°/53FT	RNP APCH
050	TF	ISERA	-	243(231.5)	-	6.5	-	+1300	-	-	RNP APCH
060	TF	MU003	-	215(203.9)	-	4.6	L	+2100	-	-	RNP APCH
070	TF	RENAX	Yes	124(112.7)	-	6.7	L	+3000	-	-	RNP APCH
080	HM	RENAX	Yes	012(001.0)	-	-	R	+3000	-	-	RNP APCH

WAYPOINT LIST

ILS Z RWY 25	
Waypoint Identifier	Coordinates
NILBA	34°40'07.21"S 055°45'11.33"W
VURDA	34°38'52.30"S 055°55'21.80"W
DOLNA	34°48'31.70"S 055°46'41.63"W
ILPOX	34°43'42.08"S 055°51'01.97"W
ATAMO	34°46'40.92"S 055°55'54.55"W
RWY25	34°49'39.56"S 056°00'47.49"W
ICAR (LLZ)	34°50'43.29"S 056°02'32.12"W
ISERA	34°53'42.70"S 056°06'54.22"W
MU003	34°57'52.03"S 056°09'15.47"W
RENAX	35°00'32.19"S 056°01'43.22"W

INSTRUMENT
APPROACH
CHART - ICAO

AERODROME ELEV **105 FT**
HEIGHTS RELATED TO
THR RWY 01 - ELEV 62 FT

TWR 118.1 - 121.8
APP 119.2 - 120.2

MONTEVIDEO/Intl
Carrasco "Gral. Av.
Cesáreo L. Berisso"
RNP Z RWY 01

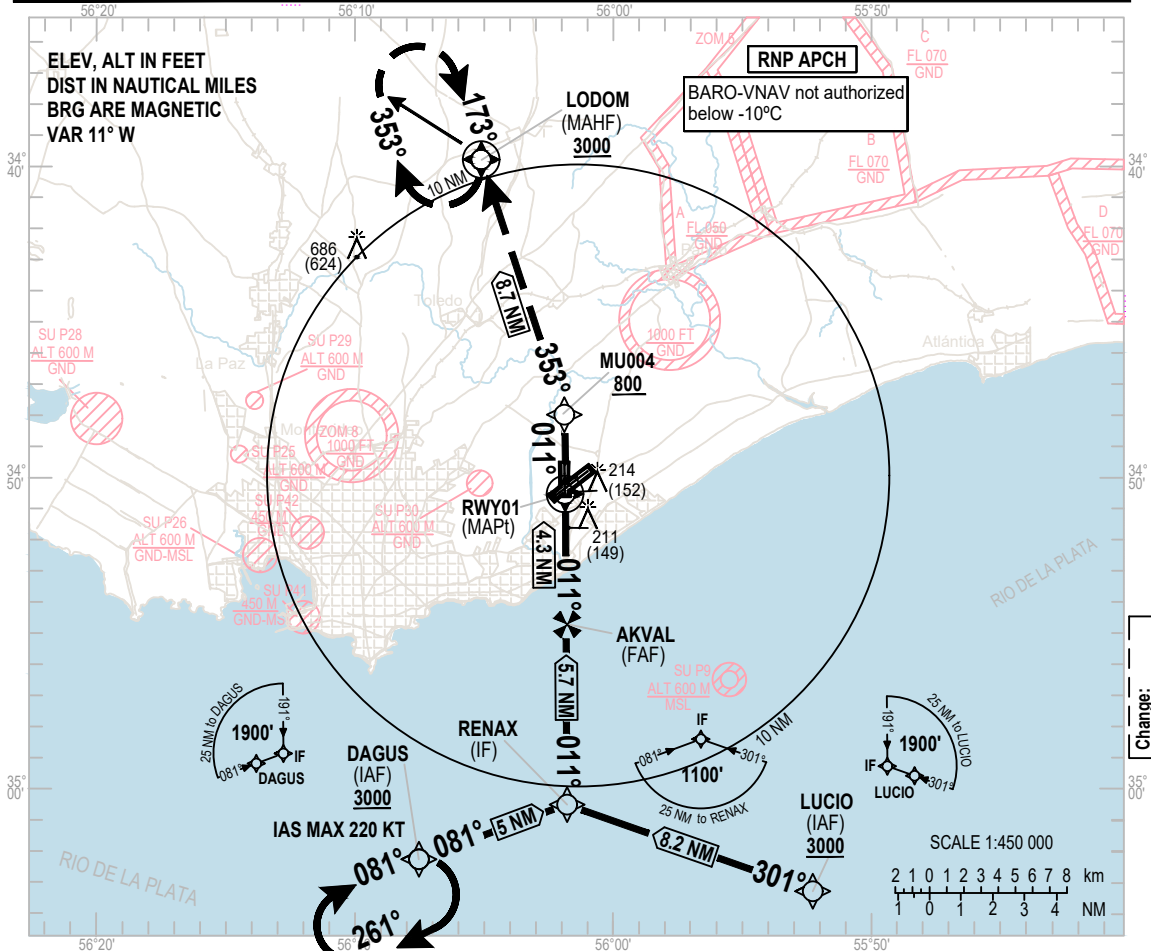

NM to next WPT	RWY01	4.2	4	3	2	1.1	0.8
ALTITUDE		1470	1386	1067	749	470	371
HEIGHT		1408	1324	1005	687	408	309

MISSED APPROACH
Climb up to 3000 FT:
heading 011° to MU004,
cross 800 FT or superior,
turn left with heading 353°
to LODOM for hold.

NOTE:
4.2% of MNM missed approach gradient
established by airspace.
If it is not possible to apply it,
inform to ATC.

TRANSITION ALT 3000

ELEV 62
(THR RWY 01)

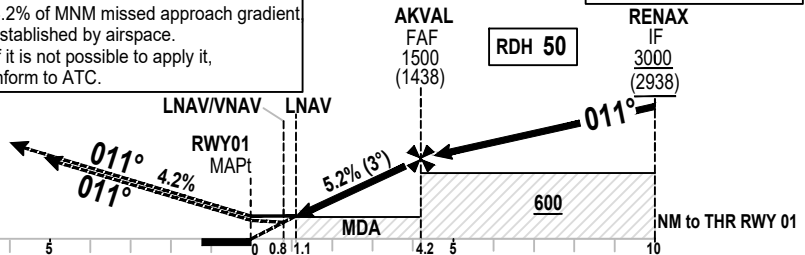

OCA / OCH	A	B	C	D
LNAV/VNAV		371(309)		
VIS	1000 M - 1400 M ALS INOP			
LNAV		470(408)		
VIS	1500 M - 1900 M ALS INOP			

Ground Speed	KT	80	100	120	140	160	180
FAF - MAPt	Feet/Min	450	550	650	750	850	1000
Vertical speed of descent 5.2%							

INSTRUMENT
APPROACH
CHART - ICAO

AERODROME ELEV **105 FT**
HEIGHTS RELATED TO
THR RWY 01 - ELEV 62 FT

TWR 118.1 - 121.8
APP 119.2 - 120.2

MONTEVIDEO/Intl
Carrasco "Gral. Av. Cesáreo L. Berisso"
RNP Z RWY 01

TABULAR DESCRIPTION

RNP Z RWY 01											
Serial Number	Path Descriptor	Waypoint Identifier	Fly-Over	Course °M(°T)	Magnetic Variation	Distance (NM)	Turn Direction	Altitude (FT)	Speed Limit (Knots/h)	VPA/TCH	Navigation Specification
010	IF	DAGUS	-	-	-	-	-	+3000	IAS 220	-	RNP APCH
020	TF	RENAX	-	081(069.6)	-	5	-	+3000	-	-	RNP APCH
010	IF	LUCIO	-	-	-	-	-	+3000	-	-	RNP APCH
020	TF	RENAX	-	301(289.6)	-	8.2	-	+3000	-	-	RNP APCH
010	IF	RENAX	-	-	-	-	-	+3000	-	-	RNP APCH
020	TF	AKVAL	-	011(359.5)	-	5.7	-	+1470	-	-3°	RNP APCH
030	TF	RWY01	Yes	011(359.5)	-	4.3	-	@112	-	-3°/50FT	RNP APCH
040	TF	MU004	-	011(359.4)	-	2.5	-	+800	-	-	RNP APCH
050	TF	LODOM	Yes	353(341.8)	-	8.7	L	+3000	-	-	RNP APCH
060	HM	LODOM	Yes	173(162.4)	-	-	R	+3000	-	-	RNP APCH

Change:
New chart

WAYPOINT LIST

RNP Z RWY 01	
Waypoint Identifier	Coordinates
DAGUS	35°02'17.00"S 056°07'25.00"W
LUCIO	35°03'18.00"S 055°52'18.00"W
RENAX	35°00'32.19"S 056°01'43.22"W
AKVAL	34°54'49.49"S 056°01'47.46"W
RWY01	34°50'31.09"S 056°01'50.65"W
MU004	34°47'59.05"S 056°01'52.53"W
LODOM	34°39'42.64"S 056°05'06.12"W

INSTRUMENT
APPROACH
CHART - ICAO

AERODROME ELEV **105 FT**
HEIGHTS RELATED TO
THR RWY 07 - ELEV 59 FT

TWR 118.1 - 121.8
APP 119.2 - 120.2

MONTEVIDEO/Intl
Carrasco "Gral. Av. Cesáreo L. Berisso"
RNP Z RWY 07

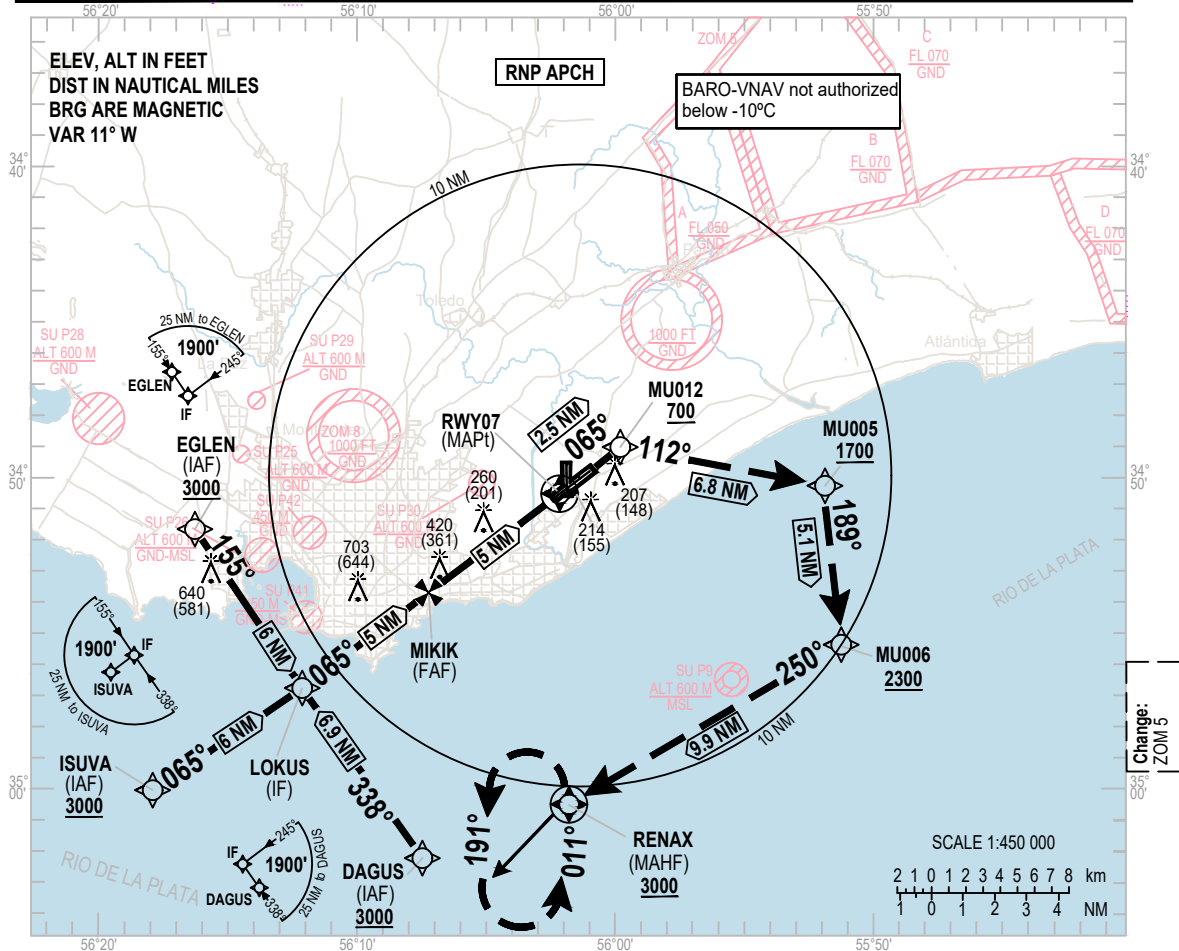

NM to next WPT	RWY07	5	4	3	2	1.1	0.7
ALTITUDE		1701	1383	1064	746	490	342
HEIGHT		1642	1324	1005	687	431	283

TRANSITION ALT 3000

NOTA:
5% of MNM missed approach gradient,
up to 1500 FT, established by airspace.

MISSED APPROACH
Climb up to 3000 FT: heading 065° to MU012, cross with 700 FT or superior, turn right heading 112° to MU005, cross with 1700 FT or superior, turn right heading 189° to MU006, cross with 2300 FT or superior, turn right heading 250° to RENAX for hold.

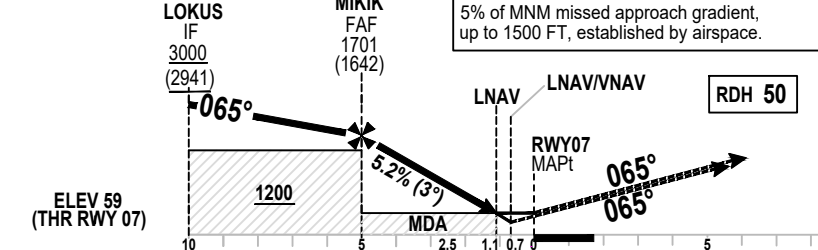

OCA / OCH	A	B	C	D
LNAV/VNAV		342 (283)		
VIS	900 M - 1400 M ALS INOP			
LNAV		490 (431)		
VIS	1500 M - 1900 M ALS INOP			

Ground Speed	KT	80	100	120	140	160	180
FAF - MAPt	Feet/Min	450	550	650	750	850	1000
Vertical speed of descent 5.2%							

INSTRUMENT
APPROACH
CHART - ICAO

AERODROME ELEV **105 FT**
HEIGHTS RELATED TO
THR RWY 07 - ELEV 59 FT

TWR 118.1 - 121.8
APP 119.2 - 120.2

MONTEVIDEO/Intl
Carrasco "Gral. Av. Cesáreo L. Berisso"
RNP Z RWY 07

TABULAR DESCRIPTION

RNP Z RWY 07											
Serial Number	Path Descriptor	Waypoint Identifier	Fly-Over	Course °M(°T)	Magnetic Variation	Distance (NM)	Turn Direction	Altitude (FT)	Speed Limit (Knots/h)	VPA/TCH	Navigation Specification
010	IF	ISUVA	-	-	-	-	-	+3000	-	-	RNP APCH
020	TF	LOKUS	-	065(053.8)	-	6	-	+3000	-	-	RNP APCH
010	IF	EGLN	-	-	-	-	-	+3000	-	-	RNP APCH
020	TF	LOKUS	-	155(143.7)	-	6	-	+3000	-	-	RNP APCH
010	IF	DAGUS	-	-	-	-	-	+3000	-	-	RNP APCH
020	TF	LOKUS	-	338(327.0)	-	6.92	-	+3000	-	-	RNP APCH
010	IF	LOKUS	-	-	-	-	-	+3000	-	-	RNP APCH
020	TF	MIKIK	-	065(053.7)	-	5	-	+1701	-	-3°	RNP APCH
030	TF	RWY07	Si	065(053.5)	-	5	-	@109	-	-3°/50FT	RNP APCH
040	TF	MU012	-	065(053.5)	-	2.5	-	+700	-	-	RNP APCH
050	TF	MU005	-	112(100.7)	-	6.77	-	+1700	-	-	RNP APCH
060	TF	MU006	-	189(177.3)	-	5.07	R	+2300	-	-	RNP APCH
070	TF	RENAX	Si	250(239.4)	-	9.9	R	+3000	-	-	RNP APCH
080	HM	RENAX	Si	011(360)	-	-	L	+3000	-	-	RNP APCH

WAYPOINT LIST

RNP Z RWY 07	
Waypoint Identifier	Coordinates
ISUVA	35°00'01.94"S 056°17'52.90"W
EGLN	34°51'37.84"S 056°16'19.33"W
DAGUS	35°02'17.00"S 056°07'25.00"W
LOKUS	34°56'28.32"S 056°12'00.00"W
MIKIK	34°53'30.10"S 056°07'06.28"W
RWY07	34°50'31.64"S 056°02'12.96"W
MU012	34°49'02.33"S 055°59'46.43"W
MU005	34°50'17.68"S 055°51'41.68"W
MU006	34°55'22.20"S 055°51'24.05"W
RENAX	35°00'32.19"S 056°01'43.22"W

INSTRUMENT
APPROACH
CHART - ICAO

AERODROME ELEV **105 FT**
HEIGHTS RELATED TO
THR RWY 19 - ELEV 51 FT

TWR 118.1 - 121.8
APP 119.2 - 120.2

MONTEVIDEO/Intl
Carrasco "Gral. Av. Cesáreo L. Berisso"
RNP Z RWY 19

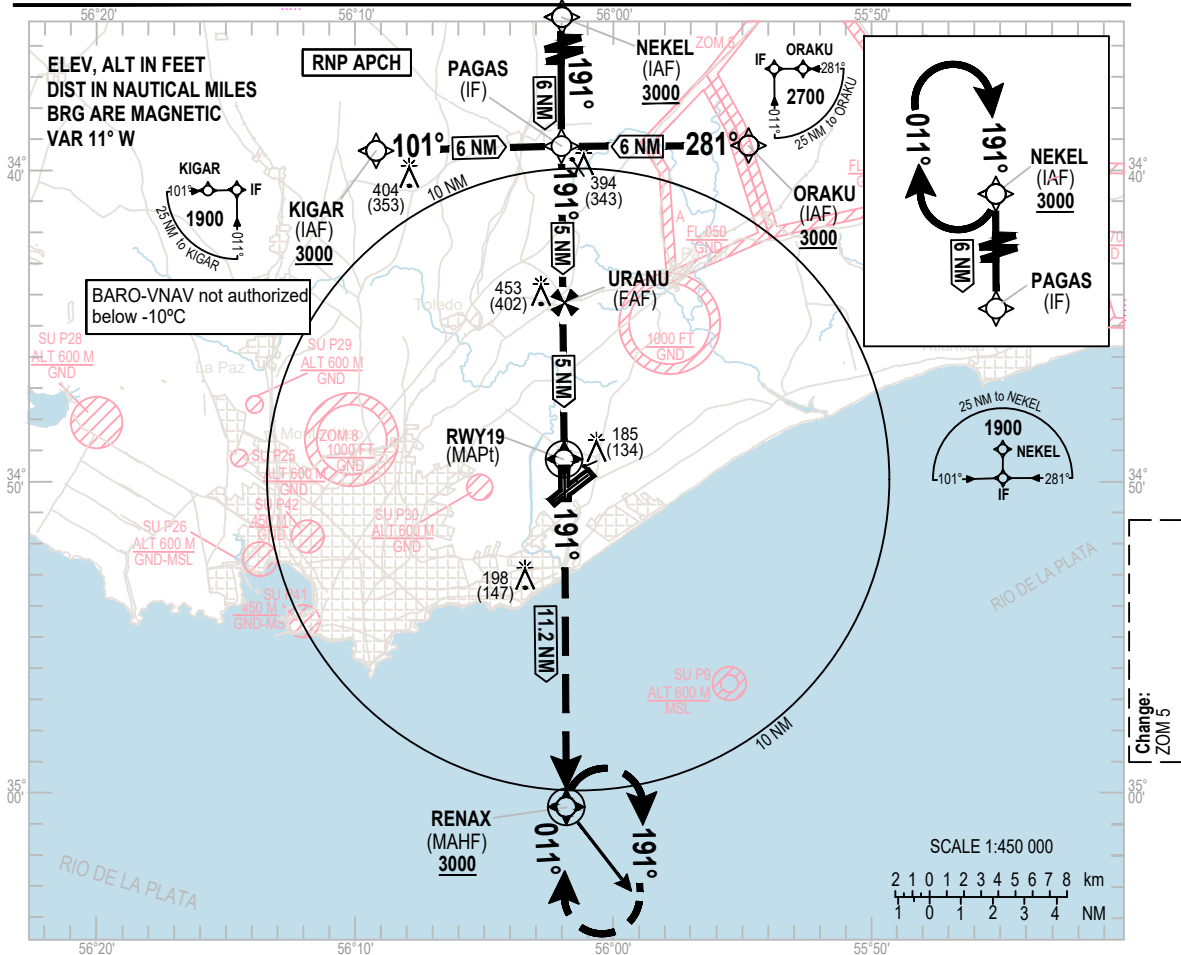

NM to next WPT	RWY19	5	4	3	2	1.6	0.8
ALTITUDE		1700	1400	1100	760	610	351
HEIGHT		1649	1349	1049	709	559	300

MISSED APPROACH
Climb up to 3000 FT heading 191° to RENAX for hold.

NOTA:
4.2% of MNM missed approach gradient, established by airspace.

RDH 50

TRANSITION ALT 3000

URANU
FAF
1700
(1649)

PAGAS
IF
3000
(2949)

ELEV 51
(THR RWY 19)

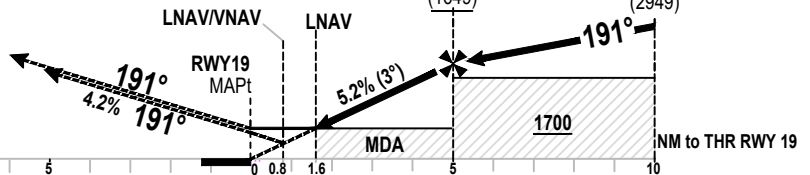

OCA / OCH	A	B	C	D
LNAV/VNAV		351(300)		
VIS	900 M - 1400 M ALS INOP			
LNAV		610(559)		
VIS	1800 M - 2500 M ALS INOP			

Ground Speed	KT	80	100	120	140	160	180
FAF - MAPt	Feet/Min	450	550	650	750	850	1000
Vertical speed of descent		5.2%					

INSTRUMENT
APPROACH
CHART - ICAO

AERODROME ELEV **105 FT**
HEIGHTS RELATED TO
THR RWY 19 - ELEV 51 FT

TWR 118.1 - 121.8
APP 119.2 - 120.2

MONTEVIDEO/Intl
Carrasco "Gral. Av. Cesáreo L. Berisso"
RNP Z RWY 19

TABULAR DESCRIPTION

RNP Z RWY 19											
Serial Number	Path Descriptor	Waypoint Identifier	Fly-Over	Course °M(°T)	Magnetic Variation	Distance (NM)	Turn Direction	Altitude (FT)	Speed Limit (Knots/h)	VPA/TCH	Navigation Specification
010	IF	NEKEL	-	-	-	-	-	+3000	-	-	RNP APCH
020	TF	PAGAS	-	191(179.4)	-	6	-	3000	-	-	RNP APCH
010	IF	KIGAR	-	-	-	-	-	+3000	-	-	RNP APCH
020	TF	PAGAS	-	101(089.4)	-	6	-	3000	-	-	RNP APCH
010	IF	ORAKU	-	-	-	-	-	+3000	-	-	RNP APCH
020	TF	PAGAS	-	281(269.4)	-	6	-	3000	-	-	RNP APCH
010	IF	PAGAS	-	-	-	-	-	3000	-	-	RNP APCH
020	TF	URANU	-	191(179.4)	-	5	-	+1700	-	-3°	RNP APCH
030	TF	RWY19	Yes	191(179.4)	-	5	-	@101	-	-3°/50FT	RNP APCH
040	TF	RENAX	Yes	191(179.4)	-	11.2	-	+3000	-	-	RNP APCH
050	HM	RENAX	Yes	011(359.5)	-	-	R	+3000	-	-	RNP APCH

Change:
New chart

WAYPOINT LIST

RNP Z RWY 19	
Waypoint Identifier	Coordinates
NEKEL	34°33'16.53"S 056°02'03.50"W
KIGAR	34°39'20.57"S 056°09'15.40"W
ORAKU	34°39'13.23"S 055°54'42.68"W
PAGAS	34°39'17.12"S 056°01'59.03"W
URANU	34°44'17.60"S 056°01'55.30"W
RWY19	34°49'18.08"S 056°01'51.56"W
RENAX	35°00'32.19"S 056°01'43.22"W

INSTRUMENT
APPROACH
CHART - ICAO

AERODROME ELEV **105 FT**
HEIGHTS RELATED TO
THR RWY 25 - ELEV 102 FT

TWR 118.1 - 121.8
APP 119.2 - 120.2

MONTEVIDEO/Intl
Carrasco "Gral. Av. Cesáreo L. Berisso"
RNP Z RWY 25

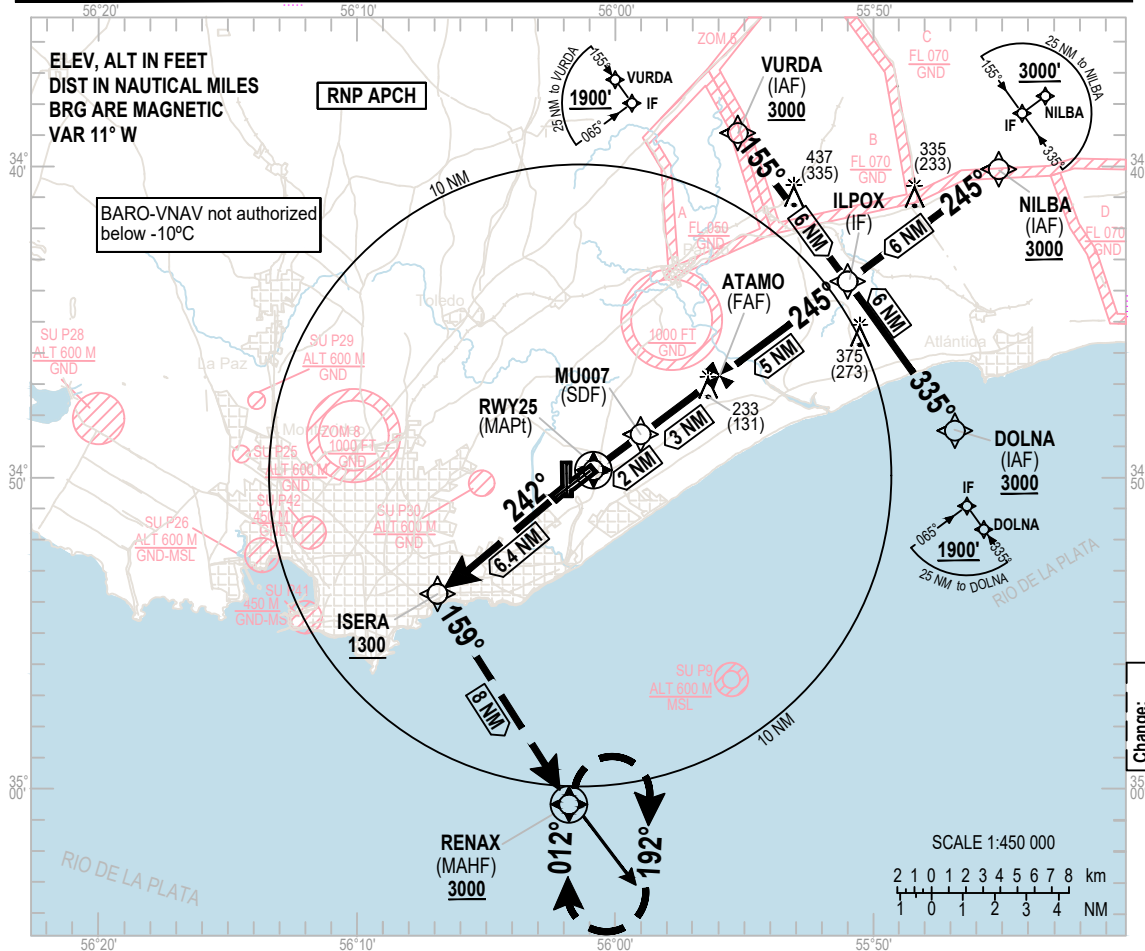

NM to next WPT	RWY25	5	4	3	2	1	0.7
ALTITUDE		1750	1426	1107	790	470	378
HEIGHT		1648	1324	1005	688	368	276

MISSED APPROACH

Climb up to 3000 FT with heading 242° to ISERA, cross at 1300 FT or superior and turn left with heading 159° to RENAX with 3000 FT or superior to hold in RENAX.

ELEV 102 (THR RWY 25)

NOTE: 5% of MNM missed approach gradient, up to 1300 FT, established by airspace.

TRANSITION ALT 3000

MU007 SDF 790 (688) ATAMO FAF 1750 (1648) ILPOX IF 3000 (2898)

RDH 50

5.2% (3°)

800

10 5 0.7 1 5 10

OCA / OCH	A	B	C	D
LNAV / VNAV		378 (276)		
VIS		750 M - 1300 M	ALS INOP	
LNAV		470 (368)		
VIS		1000 M - 1700 M	ALS INOP	

Ground Speed	KT	80	100	120	140	160	180
FAF - MAPt Vertical speed of descent 5.2%	Feet/Min	450	550	650	750	850	1000

INSTRUMENT
APPROACH
CHART - ICAO

AERODROME ELEV **105 FT**
HEIGHTS RELATED TO
THR RWY 25 - ELEV 102 FT

TWR 118.1 - 121.8
APP 119.2 - 120.2

MONTEVIDEO/Int'l
Carrasco "Gral. Av. Cesáreo L. Berisso"
RNP Z RWY 25

TABULAR DESCRIPTION

RNP Z RWY 25											
Serial Number	Path Descriptor	Waypoint Identifier	Fly-Over	Course °M(°T)	Magnetic Variation	Distance (NM)	Turn Direction	Altitude (FT)	Speed Limit (Knots/h)	VPA/TCH	Navigation Specification
010	IF	NILBA	-	-	-	-	-	+3000	-	-	RNP APCH
020	TF	ILPOX	-	245(233.3)	-	6	-	+3000	-	-	RNP APCH
010	IF	VURDA	-	-	-	-	-	+3000	-	-	RNP APCH
020	TF	ILPOX	-	155(143.5)	-	6	-	+3000	-	-	RNP APCH
010	IF	DOLNA	-	-	-	-	-	+3000	-	-	RNP APCH
020	TF	ILPOX	-	335(232.4)	-	6	-	+3000	-	-	RNP APCH
010	IF	ILPOX	-	-	-	-	-	+3000	-	-	RNP APCH
020	TF	ATAMO	-	245(233.4)	-	5	-	+1750	-	-3°	RNP APCH
030	TF	MU007	-	245(233.5)	-	3	-	+790	-	-3°	RNP APCH
040	TF	RWY25	Yes	245(233.5)	-	2	-	@152	-	-3°/50FT	RNP APCH
050	TF	ISERA	-	242(231.0)	-	6.4	-	+1300	-	-	RNP APCH
060	TF	RENAX	Yes	159(148.0)	-	8	-	+3000	-	-	RNP APCH
070	HM	RENAX	Yes	012(001.0)	-	-	R	+3000	-	-	RNP APCH

WAYPOINT LIST

RNP Z RWY 25	
Waypoint Identifier	Coordinates
NILBA	34°40'07.21"S 055°45'11.33"W
VURDA	34°38'52.30"S 055°55'21.80"W
DOLNA	34°48'31.70"S 055°46'41.63"W
ILPOX	34°43'42.08"S 055°51'01.97"W
ATAMO	34°46'40.92"S 055°55'54.55"W
MU007	34°48'28.13"S 055°58'50.27"W
RWY25	34°49'39.56"S 056°00'47.49"W
ISERA	34°53'42.70"S 056°06'54.22"W
RENAX	35°00'32.19"S 056°01'43.22"W

INSTRUMENT
APPROACH
CHART - ICAO

AERODROME ELEV **105 FT**
HEIGHTS RELATED TO
THR RWY 07 - ELEV 59 FT

TWR 118.1 - 121.8
APP 119.2 - 120.2

MONTEVIDEO/Intl
Carrasco "Gral. Av.
Cesáreo L. Berisso"
VOR Z RWY 07

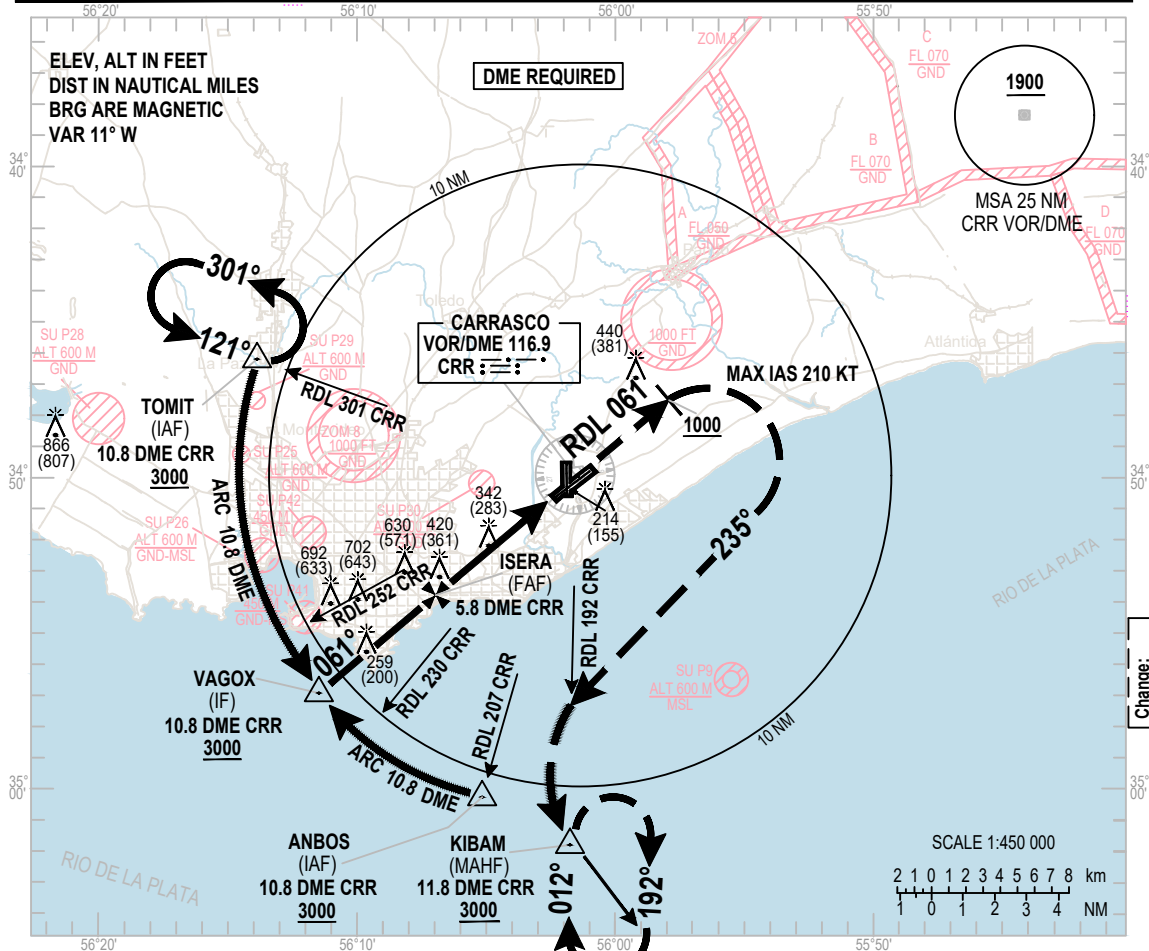

TRANSITION ALT 3000

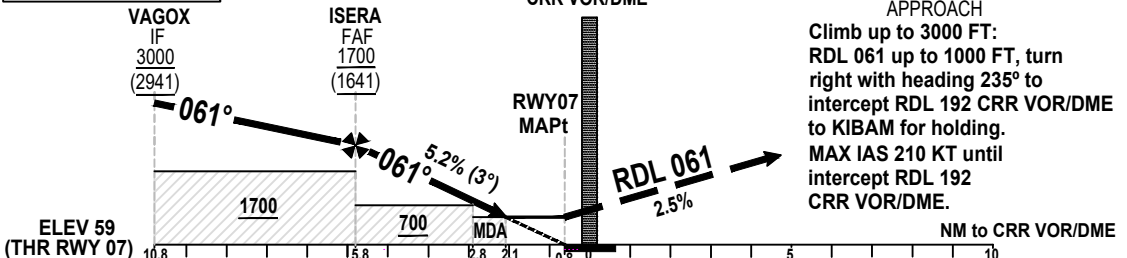

OCA/H		A	B	C	D						
Straight-in Approach	VOR/DME	510 (451)									
	VIS	1400 M - 2100 ALS INOP									
FAF a MAPt											
Vertical speed of descent 5.2%						Pies/Min	450	550	650	750	850
FAF - VOR/DME						5.8	4	3	2.8	2.1	
Altitude Height						1700	1375	1056	740	510	
						1641	1316	997	681	451	

INSTRUMENT
APPROACH
CHART - ICAO

AERODROME ELEV **105 FT**
HEIGHTS RELATED TO
THR RWY 07 - ELEV 59 FT

TWR 118.1 - 121.8
APP 119.2 - 120.2

MONTEVIDEO/Intl
Carrasco "Gral. Av.
Cesáreo L. Berisso"
VOR Z RWY 07

AERONAUTICAL DATA TABULATION

VOR Z approach to RWY 07 from TOMIT or ANBOS	
Fix / Point	Coordinates
TOMIT (IAF)	34°46'16.68"S 056°13'50.82"W
ANBOS (IAF)	35°00'22.17"S 056°05'07.51"W
VAGOX (IF)	34°56'56.17"S 056°11'33.37"W
ISERA (FAF)	34°53'42.70"S 056°06'54.22"W
MU008 (SDF)	34°52'20.62"S 056°04'55.97"W
MU009 (FTP) (MAPT)	34°50'29.05"S 056°02'15.44"W
RWY07	34°50'31.64"S 056°02'12.96"W
VOR/DME CRR	34°49'57.8"S 056°01'30.5"W
KIBAM (MAHF)	35°01'49.08"S 056°01'44.77"W

Change:
New chart

INSTRUMENT
APPROACH
CHART - ICAO

AERODROME ELEV **105 FT**
HEIGHTS RELATED TO
THR RWY 25 - ELEV 102 FT

TWR 118.1 - 121.8
APP 119.2 - 120.2

MONTEVIDEO/Intl
Carrasco "Gral. Av.
Cesáreo L. Berisso"
VOR Z RWY 25

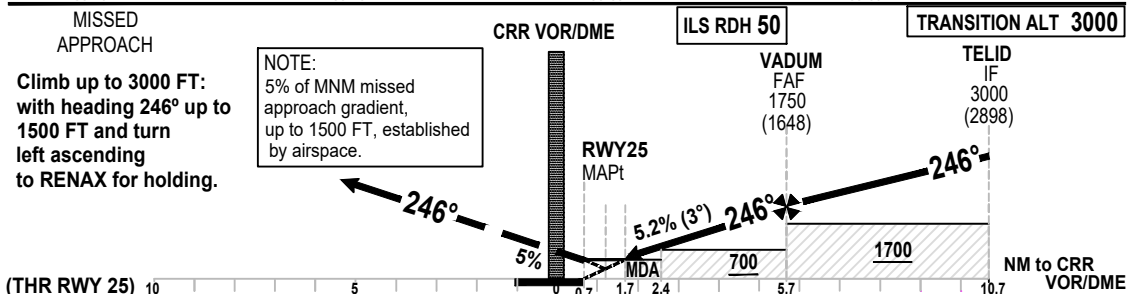
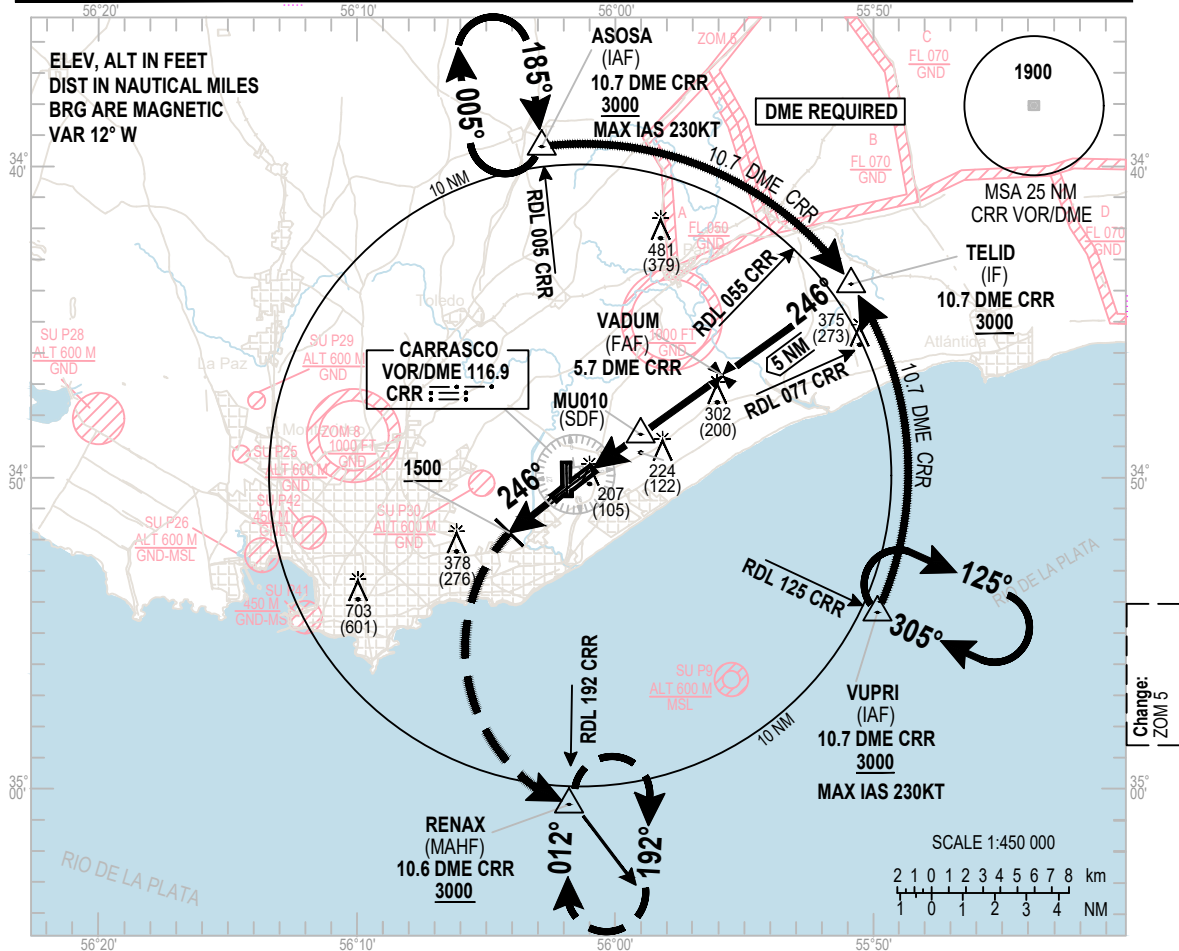

OCA/H		A	B	C	D			KT	90	110	130	150	170
Straight-in Approach	VOR/DME	470 (365)											
	VIS	1000 M - 1700 M ALS INOP											
VADUM - RWY 25 (5 NM)								Feet/Min	450	550	650	750	850
Vertical speed of descent 5.2%													
NM to CRR VOR						1.7	2	3	4	5.7			
Altitude						470	740	1056	1375	1750			
Height						365	638	954	1273	1648			

INSTRUMENT
APPROACH
CHART - ICAO

AERODROME ELEV **105 FT**
HEIGHTS RELATED TO
THR RWY 25 - ELEV 102 FT

TWR 118.1 - 121.8
APP 119.2 - 120.2

MONTEVIDEO/Intl
Carrasco "Gral. Av.
Cesáreo L. Berisso"
VOR Z RWY 25

AERONAUTICAL DATA TABULATION

VOR Z approach to RWY 25 from ASOSA or VUPRI	
Fix / Point	Coordinates
ASOSA (IAF)	34°39'20.76"S 056°02'49.81"W
VUPRI (IAF)	34°54'18.98"S 055°49'41.07"W
TELID (IF)	34°43'48.63"S 055°50'56.29"W
VADUM (FAF)	34°46'41.95"S 055°55'53.65"W
MU010 (SDF)	34°48'32.79"S 055°59'04.17"W
MU011 (FTP) (MAPT)	34°49'35.09"S 056°00'51.40"W
RWY25	34°49'39.56"S 056°00'47.49"W
CRR VOR/DME	34°49'57.8"S 056°01'30.5"W
RENAX (MAHF)	35°00'32.19"S 056°01'43.22"W

Change:
New chart

ATC SURVEILLANCE
MINIMUM ALTITUDE
CHART - ICAO

AERODROME ELEV 105 FT
TRANSITION ALT 3000 FT

SUMU APP
119.2 - 120.2

MONTEVIDEO/Intl
Carrasco "Gral. Av.
Cesáreo L. Berisso"

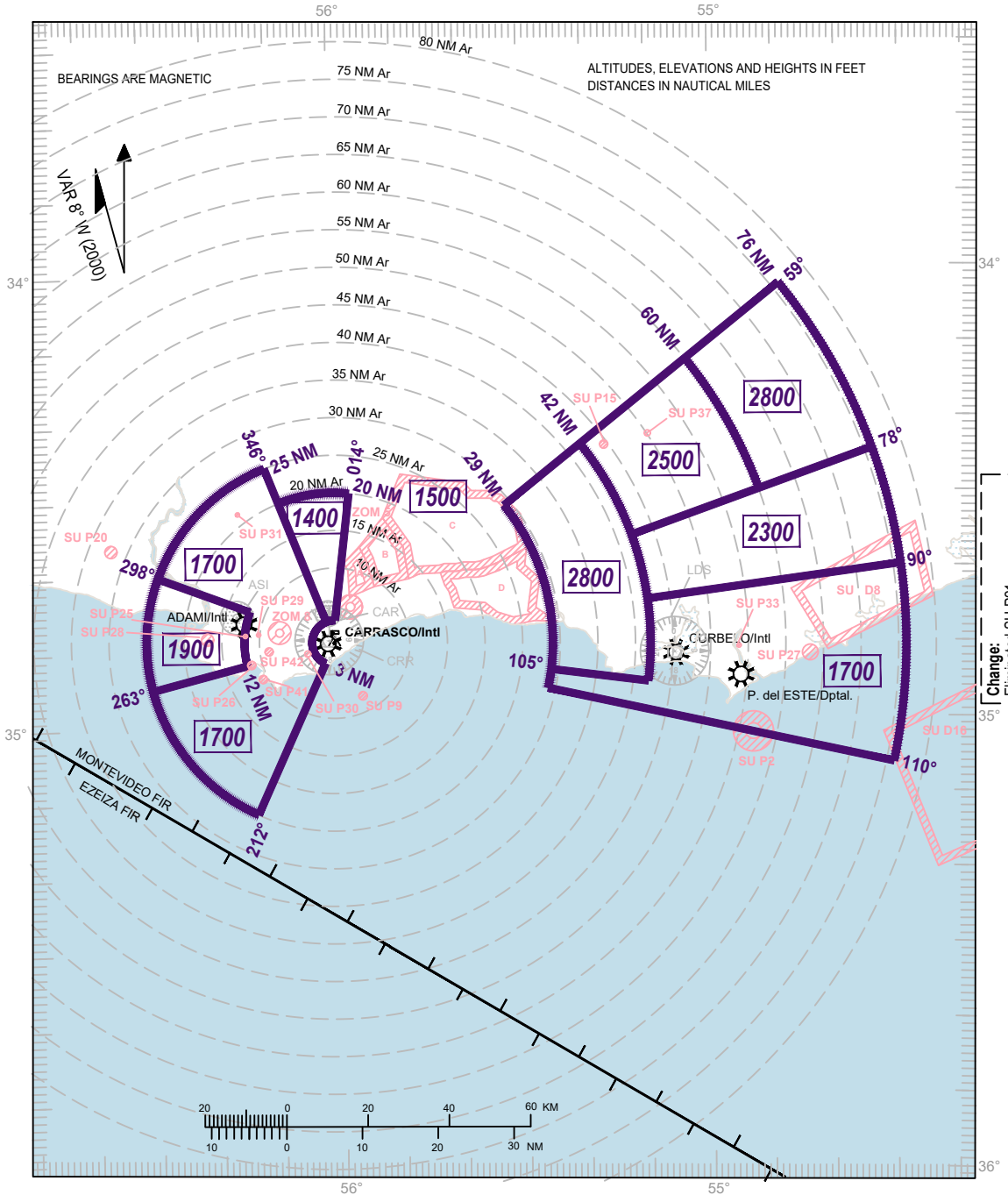

**INTENTIONALLY
LEFT BLANK**

**INTENTIONALLY
LEFT BLANK**